



**TITLE: Refrigerator or combined refrigerator and water-pack freezer: solar powered with rechargeable battery.**

*Product verification protocol:* E003/RF04-VP.3  
*Applies to specification ref(s):* E003/RF04.3  
*Issue date:* 6 July 2010  
*Date of last revision:* 26 April 2017

**Contents:**

**1. Scope: ..... 2**

**2 Normative references:..... 2**

**3. Terms and definitions:..... 3**

**4. Applicability: ..... 5**

**5. Type-testing procedure: ..... 5**

5.1 Evidence of conformity assessment: ..... 5

5.2 Number of samples: ..... 5

5.3 Test procedure:..... 6

5.3.1 *Test 1: Type examination:*..... 6

5.3.2 *Test temperatures:* ..... 8

5.3.3 *Test 2: Cool-down, initial stabilization and energy consumption:*..... 8

5.3.4 *Test 3: Stable running and energy consumption:* ..... 8

5.3.5 *Test 4: Water-pack freezing capacity, storage compartment capacity, & energy consumption:*..... 9

5.3.6 *Test 5: Day/night, frozen water-pack storage & energy consumption.*12

5.3.7 *Test 6: Holdover time:* ..... 12

5.3.8 *Test 7: Freeze protection classification:*..... 13

5.3.9 *Test 8: Door opening:*..... 13

5.3.10 *Test 9: Minimum rated ambient temperature:* ..... 13

5.4 Test criteria for qualification: ..... 14

**6. Quality control checklist: ..... 15**

6.1 Quality control standards: ..... 15

6.2 Quality control checklist: ..... 15

6.3 Quality control evaluation:..... 15

**7. Pre-qualification evaluation:..... 15**

**8. Modified appliances:..... 15**

**Annex 1 – General test conditions ..... 16**

**Annex 2 – Temperature sensor positions ..... 18**

**Annex 3 – Temperature sensor specification..... 22**

**Annex 4 – Methodology for the measurement of ice production..... 22**

**Annex 5 – Methodology for freeze protection analysis and grading ..... 22**

**Revision history:..... 24**

**1. Scope**

This document describes the procedure for verifying the performance of refrigerators or combined refrigerator and water-pack freezers powered by solar electricity with a battery energy storage system. Previously, an appliance

that passed the relevant tests would be pre-qualified with a specific temperature zone designation. Three temperature zones are described: **moderate zone**, **temperate zone** and **hot zone**; the scope of each category is defined in Section 3. However, from the point of issuance of this verification protocol, all appliances must pass the relevant tests in the **hot zone**. In addition appliances must demonstrate a minimum **rated ambient temperature** of +10°C or lower. This is in accordance with the revised performance specification as described in PQS E003/RF04.3.

## 2. Normative references

- EMAS: *European Union Eco-Management and Audit Scheme*.
- EN ISO 6270-1 / ASTM D2247 / EN 13523-26: *Determination of resistance to humidity – Part 1: Continuous condensation*.
- EN ISO 6270-2 / EN 13523-25: *Determination of resistance to humidity - Part 2: Procedure for exposing test specimens in condensation-water atmospheres*.
- GHS Rev 5. *United Nations: Globally Harmonized System of Classification and Labelling of Chemicals*.
- IEC 60335-1: *Amendment 1: Household and similar electrical appliances - Safety - Part 1: General requirements*.
- IEC 60335-2-24: 2007: *Household and similar electrical appliances - Safety - Part 2-24: Particular requirements for refrigerating appliances, ice-cream appliances and ice-makers*.
- IEC 60364-1: 2005: *Low-voltage electrical installations - Part 1: Fundamental principles, assessment of general characteristics, definitions*.
- IEC 61000-6-1 edition 2.0: 2005: *Electromagnetic compatibility (EMC) Generic standards - Immunity for residential, commercial and light-industrial environments*.
- IEC 61000-6-3 edition 2.1: 2011: *Electromagnetic compatibility (EMC) Generic standards - Emission standard for residential, commercial and light-industrial environments*.
- IEC 62552: 2007: *Household refrigerating appliances – Characteristics/tests*.
- ISO 2409: 2013: *Paints and varnishes – cross cut test (external cabinet)*.
- ISO 6272 / EN 13523-5: *Impact resistance - external cabinet*.
- ISO 9001: *Quality Management Systems – Requirements*.
- ISO 14001: 2004: *Environmental management systems - Requirements with guidance for use*.
- ISO 20282-1: 2006: *Ease of operation of everyday products - Part 1: Context of use and user characteristics*.
- ISO/IEC 17025: 2005: *General requirements for the competence of testing and calibration laboratories*.
- WHO/PQS/E005/IP01: *Water-packs for use as ice-packs, cool-packs and warm-packs*.
- WHO/PQS/E006/TH02.2: *Fixed gas or vapour pressure dial thermometer*.
- WHO/PQS/E006/TH06.2: *Integrated electronic maximum-minimum thermometer, with factory programmed alarms, for vaccine refrigerators and freezers*.

### 3. Terms and definitions

**Acceptable temperature range:** The acceptable temperature range for storing vaccine is +2°C to +8°C. However, transient excursions outside this range will be tolerated, within the following limits:

- No excursion must exceed +20°C ( $\pm 0.5^\circ\text{C}$ ) for any amount of time.
- No excursion must drop below -0.5°C for any amount of time.
- No excursion must drop below 0°C for longer than 1 hour.
- Following an excursion below 0°C, the appliance must return to safe operating temperature (i.e., consistently between +2°C and +8°C) within 2 hours. This duration will be measured from the moment the temperature drops below 0°C and up until it returns to +2°C.

The cumulative effect of any excursions within the above range will be assessed over the five day period of the *day/night* test. For this test, the calculated mean kinetic temperature (MKT)<sup>1</sup> must remain within the range +2°C to +8°C when the default activation energy is set at 83,144 kJ per mol. Using the recorded temperature data, an MKT figure will be calculated for each sensor. The worst-case result will determine the outcome of the test. Excursions in other tests will be noted and must not exceed the defined upper and lower limits.

**Autonomy (freezer):** Time in days that the water-pack freezer can maintain the minimum capacity of fully frozen water-packs under low solar power conditions (rain) with battery power only.

**Autonomy (refrigerator):** Time in days that a solar refrigerator, or combined refrigerator and water-pack freezer, can maintain the vaccine load within the acceptable temperature range under low solar power conditions (rain) with battery power only. Installation site autonomy is determined as described in **E003/PV01** – Section 4.1.2.

**Freezing temperature (on walls/lining of vaccine compartment):**

For sensors placed in direct contact with the walls/lining of the vaccine compartment, freezing temperature is defined as any of the following conditions:

- Excursion between -0.5°C and 0°C for longer than 1 hour.
- Excursion equal to or below -0.5°C for any amount of time.
- Inability to return to safe operating temperature (i.e., consistently between +2°C and +8°C) within 2 hours following an excursion equal to or below 0°C.

**Freeze-protection classification:**

- **Grade A, User-Independent Freeze Protection (UIFP):** When the appliance is used within its nominated temperature range (temperature zone +43°C, +32°C or +27°C and minimum rated ambient temperature) there is no intervention required by the user to ensure that the vaccines will not be exposed to freezing temperatures below 0°C whatever the position of the vaccine in the vaccine compartment.
- **Grade B, User-Dependent Freeze Protection (UDFP):** Even if the appliance is used within its nominated temperature range, the user must

---

<sup>1</sup> Refer to Seevers, R. et al. The Use of Mean Kinetic Temperature (MKT) in the Handling, Storage and Distribution of Temperature Sensitive Pharmaceuticals. Pharmaceutical Outsourcing, May/June 2009.

comply with a procedure provided by the manufacturer and requiring one level of intervention in order to avoid vaccine freezing temperatures (e.g., the requirement to use baskets or other items).

- **Grade C, User-Dependent Freeze Protection (UDFP):** Even if the appliance is used within its nominated temperature range, the user must comply with a procedure provided by the manufacturer requiring more than one level of intervention in order to avoid vaccine freezing temperatures (e.g., the requirement to use baskets and insulation barriers or covers).

**Gross volume:** The measured volume of the airspace inside the internal compartment of the appliance with the door or lid shut. For combined appliances the gross freezer volume and the gross refrigerator volume are reported separately.

**Holdover time:** The time in hours during which all points in the vaccine compartment remain between +2°C and +8°C, at the maximum ambient temperature of the temperature zone for which the appliance is rated, after the power supply has been disconnected.

**Hot zone:** Hot zone units must operate at a steady +43°C ambient temperature and over a +43°C/+25°C day/night cycling temperature range.

**Ice-pack storage capacity:** The maximum number of fully frozen water-packs that can remain fully frozen at the end of water-pack storage compartment testing over a multi-day period.

**In writing:** means communication by letter, fax or email.

**Installation:** The appliance specified in this document, connected to a **Type 1** solar power system complying with specification **E003/PV01**.

**Legal manufacturer:** The natural or legal person with responsibility for the design, manufacture, packaging and labelling of a product or device before it is placed on the market under her/his own name, regardless of whether these operations are carried out by that person or on her/his behalf by a third party.

**Minimum rated ambient temperature:** The lowest constant ambient temperature at which the acceptable temperature range can be maintained with a full vaccine load. All models must be able to operate at a continuous minimum ambient temperature of +10.0°C or lower whilst maintaining the acceptable temperature range.

**Moderate zone:** Moderate zone appliances must operate at a steady +27°C ambient temperature and over a +27°C/+10°C day/night cycling temperature range.

**Montreal Protocol:** Montreal Protocol on Substances that Deplete the Ozone Layer.

**Primary container:** Vial, ampoule, prefilled device, plastic dispenser or tube containing vaccine or diluent. Some products are supplied in a light card carton containing a single vial, ampoule, vial pair, vial-ampoule pair, or prefilled device.

**Reseller:** A commercial entity, licensed to act on behalf of a Legal manufacturer, and which carries product liability and warranty responsibilities no less onerous than those carried by the Legal manufacturer.

**Solar radiation reference period:** The minimum average daily solar radiation on the plane of the solar array that is required to properly power the solar refrigerator, or combined refrigerator and water-pack freezer, expressed in kWh/m<sup>2</sup>/day.

**Temperate zone:** Temperate zone units must operate at a steady +32°C ambient temperature and over a +32°C/+15°C day/night cycling temperature range.

**User-Dependent Freeze Protection (UDFP):** Refrigeration technology that requires appliance users (e.g., healthcare workers) to perform specific actions (User-Interventions) in order to ensure vaccine protection against freezing temperatures (e.g., store vaccines in baskets, away from compartment wall surfaces).

**User-Independent Freeze Protection (UIFP):** User-Independent Freeze Protection (UIFP): Refrigeration technology that requires appliance users (e.g., healthcare workers) to perform no specific actions (User-Interventions) in order to ensure vaccine protection against freezing temperatures.

**User-Intervention:** Any activity that is required to be executed by appliance users in order to ensure vaccine protection against freezing temperatures. Activities include, but are not limited to, basket storage, storage compartment covers, thermostat/fuel adjustment, and combustion component replacement.

**Vaccine net storage capacity:** The net storage capacity is the space where it is suitable (both thermally and ergonomically) to store vaccines. Where manufacturers are declaring more than one vaccine storage capacity for the same gross volume and external dimensions, manufacturers must prequalify with different branding, one model for each different storage volume.

**Water-pack:** A flat, leak proof, plastic container, filled with tap water, complying generally with specification **E005/IP01**.

**Water-pack freezing capacity:** The daily maximum weight of fully frozen water-packs which remain at the end of the night phase of the water-pack freezing capacity test.

#### **4. Applicability**

Type-testing will be carried out by an independent ISO/IEC 17025 testing laboratory, accredited by WHO.

#### **5. Type-testing procedure**

##### **5.1 Evidence of conformity assessment**

Appliances must carry the CE mark, UL mark and/or equivalent internationally accepted evidence of conformity assessment.

##### **5.2 Number of samples**

The **Legal Manufacturer** or **Reseller** must supply the testing laboratory with a full duplicate set of the Product Dossier already supplied to WHO in accordance with the requirements of specification clause 7. One sample of the appliance is required. Ensure that the voltage and frequency rating of the sample(s) is suitable for the country where the test laboratory is located<sup>2</sup>.

---

<sup>2</sup> If there is any doubt that the performance of the appliance will vary under the other nominal voltage/frequency combinations supplied by the manufacturer, he must be asked to comment [in writing](#).

## 5.3 Test procedure

### 5.3.1 *Test 1: Type examination*

- **Step 1:** Unpack the appliance. Using the manufacturer's installation instructions only, set up the system components. Record the process and any problems encountered.
- **Step 2:** Check all samples for similarities between different models<sup>3</sup>, dissimilarities between samples of one model, any defects or damage or any problem that make it difficult or impossible to test the appliance.
- **Step 3:** Record any differences between the samples ordered and those received.
- **Step 4:** Tabulate the following information for each model submitted for examination. Obtain any additional supporting information required [in writing](#) from the [Legal Manufacturer](#) or [Reseller](#) and attach this information to the report:

#### *Identification*

- Code (a unique identifier to be assigned by the testing laboratory);
- Model;
- [Legal Manufacturer](#) or [Reseller](#);
- Appliance type (i.e. vaccine refrigerator or combined appliance);
- Country of origin;
- Conformity assessment markings (e.g. CE mark);
- Temperature zone rating against which the appliance is to be tested.

#### *Performance characteristics (Note: laboratory is to report by clause and in this same order as below)*

- Temperature zone rating sticker conforms/does not conform to **Annex 1** design (specification clause 4.2.1).
- Refrigeration type and input voltage conforms/does not conform to specification clause 4.2.2.
- Design of vaccine storage compartment conforms/does not conform to specification clause 4.2.3.
- Vaccine [freeze protection classification](#) sticker conforms/does not conform to **Annex 3** specification clause 4.2.4 (note **Grade A, B or C**).
- Combined appliances only: Water-pack storage compartment capacity conforms/does not conform to specification clause 4.2.6.
- Thermostat type conforms/does not conform to specification clause 4.2.8.
- Temperature monitoring and thermometer conforms/does not conform to specification clause 4.2.9.
- Indicator light conforms/does not conform to specification clause 4.2.10.
- Condensation management and defrost conforms/does not conform to specification clause 4.2.14.
- Lock conforms/does not conform to specification clause 4.2.15.
- Corrosion resistance conforms/does not conform to specification clause 4.2.16.
- Electrical safety rating conforms/does not conform to specification clause 4.2.17.

---

<sup>3</sup> The purpose of this inspection is to establish whether appliances offered by competing companies are re-badged versions of an otherwise identical appliance.

- Markings conform/do not conform to specification clause 4.2.18.
- Vaccine storage advice conforms/does not conform to specification clause 4.2.19.
- Electromagnetic compatibility conforms/does not conform to specification clause 4.2.20.

*Environmental requirements:*

- Ambient temperature range during transport and storage conforms/does not conform to specification clause 4.3.1.
- Ambient humidity range during transport, storage and use conforms/does not conform to specification clause 4.3.2.

*Physical characteristics:*

- Overall dimensions conform/do not conform to specification clause 4.4.1.
- Weight conforms/does not conform to specification clause 4.4.2.

*Interface requirements:*

- Electrical components conform/do not conform to specification clause 4.5.1.
- Power switch conforms/does not conform to specification clause 4.5.2.

*Human factors:*

- General design of the product conforms/does not conform to specification clause 4.6.1. Manufacturer to certify in writing that the conformance to clause 4.6.1.
- Control panel, indicator light, and thermometer conform/do not conform to specification clause 4.6.2.
- PQS stickers conform/do not conform to specifications clause 4.6.3.

*Materials and construction:*

- Record materials of all major visible components.
- Refrigerant conforms/does not conform to clause 4.7.1.
- Thermal insulation foaming agent conforms/does not conform to specification clause 4.7.2.
- Other restricted materials listed in clause 4.7.3 are/are not present.

*Physical data:*

- Record major rectangular dimensions in centimetres ( $\pm 1.0$  cm).
- Record weight in kilograms ( $\pm 0.25$  kg).
- Record internal volume of refrigerator and freezer compartment in litres.
- Record gross volume of all vaccine and water-pack storage compartments
- Record estimated vaccine net storage capacity in litres.
- Record maximum water-pack capacity in kilograms (if freezer included).

*Warranty*

- Warranty conforms/does not conform to specification clause 4.8.

*Essential spare parts*

- Spare fuses conforms/does not conform to specification clause 4.9.1.
- List of spare parts conforms/does not conform to specification clause 4.9.1.

*Disposal and recycling*

- Hazardous materials information conforms/does not conform to specification clause 4.10.

*Instructions:*

- Instructions conform/do not conform to specification clause 4.11.



### *Packaging*

- Packaging conforms/does not conform to specification clause 5.

**Step 5:** Take a three quarter view digital photograph of the appliance with the door open. Take additional photographs showing all external surfaces of the appliance, the interior layout, the [vaccine storage compartment](#), the cooling system and a close-up of the thermometer, indicator light(s), the control(s), control panel and any special features or identified weaknesses of the appliance. High resolution digital images should be provided for attachment to the PQS report.

**Acceptance criteria:** Inspection indicates full conformity with all major specification requirements. System setup must be straightforward and trouble-free.

### 5.3.2 *Test temperatures*

All appliances are to be tested to [hot zone](#) temperatures and per **Annexes 1, 2 and 3**. Record test room ambient and internal cabinet temperatures for at least 48 hours prior to all tests.

### 5.3.3 *Test 2: Cool-down, initial stabilization, and energy consumption:*

- **Step 1:** Set the test chamber temperature to +43°C and leave for 48 hours with the appliance empty, the lid or door open, and the energy supply switched off.
- **Step 2:** Close the lid or door of the appliance, commence with energy supply for a 24 hour period and leave it to initially stabilize. Initial stabilization is accomplished when the appliance demonstrates all of the following:
  - The internal temperatures in the [vaccine storage compartment](#) are within the [acceptable temperature range](#); and
  - The cooling system has exhibited consistent on/off operation for the final two days of this test (e.g. the same number of on/off cycles per day for the final two days).
- **Step 3:** During stabilization, record temperatures every minute, and continue to do so for 24 hours after stabilization. During this period measure the energy consumption and determine the duty cycle. Measure the duty cycle by timing from the end of one cycle to the end of a corresponding cycle approximately 24 hours later. Calculate the percentage 'on' time over this period. Measure electricity consumption over the same time scale and report as kWh/day.
- **Acceptance criterion:** Stabilized internal temperatures between +2°C and +8°C in the vaccine storage compartment and below -3°C in the water-pack freezing compartment (if present) achieved within the test period (after stabilization). No standard set for the cool-down time but the period will be reported.
- **Rejection criterion:** Failure to stabilize within the [acceptable temperature range\(s\)](#). Halt the test if the appliance does not initially stabilize within the period specified by the [Legal Manufacturer](#), plus one day.

### 5.3.4 *Test 3: Stable running and energy consumption:*

- **Step 1:** When the internal temperature is stabilized at the end of Test 2, load the appliance with simulated, pre-conditioned vaccine as described in



**Annex 1.** Ensure that the water-pack freezing compartment (if present) is empty.

- **Step 2:** Close the lid or door of the appliance and leave it to stabilize the internal temperatures between +2°C and +8°C and reach a state where the cooling circuit is cycling due to thermostat regulation.
- **Step 3:** After temperature stabilization has been achieved, record temperatures every minute for 24 hours. During this period measure the energy consumption and determine the cooling circuit duty cycle. Measure the duty cycle by timing from the end of one cycle to the end of a corresponding cycle approximately 24 hours later. Calculate the percentage 'on' time over this period, graphically display on/off cycles and report electricity consumption over the same time scale as kWh/day.
- **Acceptance criteria:** Stabilized internal temperatures maintained between +2°C and +8°C in the vaccine storage compartment and below -3°C in the water-pack freezing compartment (if present). No standard set for energy consumption but the figure will be reported.
- **Rejection criterion:** Failure to meet one or more of the acceptance criteria.

5.3.5 *Test 4: Water-pack freezing capacity, storage compartment capacity and energy consumption:*

**Application:** Combined appliances only.

- **Step 1:** Continue the Test 3 conditions. DO NOT adjust the freezer thermostat.
- **Step 2:** Stabilize water-packs at +43°C.
- **Step 3:** Load a minimum of 1.6 kg of water-packs and not less than 2.4 kg per 50 litres of gross freezer volume of water-packs into the freezer compartment. Load the packs in accordance with user instructions including any rack or structure provided. Install the freezer thermocouples, centred as uniformly as possible between the loaded water-packs. The minimum distance between a thermocouple and the lid/door, wall or evaporator should be 30mm.
- **Step 4:** Record freezer and refrigerator compartment temperatures every minute for the following 24 hours. Measure electricity consumption and the cooling system duty cycle over the same duration.
- **Step 5:** At the end of the 24 hour test period check that the water-packs are fully frozen (refer to **Annex 4** for methodology measurement of ice production). Check that the vaccine load has remained within the +2°C and +8°C range throughout the 24 hour test period. Remove the frozen water-packs.
- **Step 6:** Repeat steps 3 to 5 introducing larger loads of stabilized water-packs up to the point when one or more of the following conditions occurs:
  - the total net weight of fully frozen **water-packs** has not increased since the previous cycle; or
  - until the freezing compartment is full; or
  - the temperature of the vaccine load breaches the +2°C to +8°C range on one or more sensors.

Establish and record the maximum weight of **water-packs** that can be fully frozen whilst still meeting the requirements of specification clause 4.2.5 (refer to **Annex 4** for the methodology for measurement of ice production). This is

the appliance's daily **water-pack freezing capacity**. Measure electricity consumption over the same time scale and report energy consumption in kWh/day.

**Step 7:** At the start of the next 24 hour cycle load **water-packs** equal to the minimum daily **water-pack freezing capacity** determined in Step 6 into the freezer compartment in accordance with user instructions which includes any rack or structure provided for holding **water-packs**. The process to achieve the maximum freezing capacity must be stated in the user instructions.

**Step 8:** Record freezer and refrigerator compartment temperatures every minute for the following 24 hours. Measure electricity consumption and the cooling system duty cycle over the same duration. Report energy consumption in kWh/day, percentage on-time over the same time scale and graphically display on/off cycles.

**Step 9:** At the end of the next 24 hour period remove all **water-packs** and quickly determine which are fully frozen and which are not fully frozen per instructions in **Annex 1 – Fully frozen water-pack determination**. Record each **water-pack** volume, location and condition (i.e. fully frozen or not fully frozen). Replace all packs immediately and add more stabilized **water-packs** in accordance with user instructions. Note: It must be possible to remove frozen **water-packs** without any undue force or delay. Defrosting the freezer to enable removal is not acceptable.

**Step 10:** Repeat Steps 7 to 9 up to the point when either:

- the total net weight of fully frozen **water-packs** has not increased since the previous cycle; or
- until the freezing compartment is full; or
- the temperature of the vaccine load breaches the +2°C to +8°C range on one or more sensors.

The number and volume of fully frozen **water-packs** at the end of Step 10 are to be reported. This is the appliance's **water-pack storage compartment capacity**.

**Acceptance criteria (water-pack freezing capacity):** Stabilized internal temperatures maintained between +2°C and +8°C in the **vaccine storage compartment**. For freezers of less than 50 litres of gross freezer volume a minimum of 1.6 kg of fully frozen **water-packs** must remain fully frozen at the end of a 24 hour test phase whilst maintaining the temperature control specified in 4.2.7. For freezers with at least 50 litres of gross freezer volume a minimum of 2.4 kg of fully frozen **water-packs** per 50 litres of gross freezer volume must remain fully frozen at the end of a 24 hour test phase whilst maintaining the temperature control specified in 4.2.7. No standard set for power consumption but report the energy consumption in kWh/day, the percentage on-time during the test time and graphically display on/off cycles.

**Acceptance criteria (water-pack storage compartment capacity):** Stabilized internal temperatures maintained between +2°C and +8°C in the vaccine storage compartment. For freezers of less than 50 litres of gross freezer volume a minimum of 3.4 kg of fully frozen **water-packs** must remain fully frozen at the end of Step 10 whilst maintaining the temperature control specified in 4.2.7. For freezers with at least 50 litres of gross freezer volume a minimum of 4.8 kg of fully frozen **water-packs** per 50 litres of gross freezer volume must remain fully frozen at the end of Step 10 whilst maintaining the temperature control specified in 4.2.7. No standard set for power consumption

but report the energy consumption in kWh/day, the percentage on-time during the test time and graphically display on/off cycles.

**Rejection criterion:** Failure to meet one or more of the acceptance criteria.

5.3.6 *Test 5: Day/night, frozen water-pack storage, and energy consumption:*

**Application:** Day/night and energy consumption apply to all appliances.

Frozen [water-pack](#) storage instructions apply only to combined appliances.

- **Step 1:** Incorporating the result from Test 4, allow the appliance to stabilize for a further 24 hours only with the [water-pack](#) freezing compartment filled equivalent to the final [water-pack storage compartment capacity](#) result from Test 4.
- **Step 2:** For further loading (see Step 6), label and stabilize additional water-packs at +43°C.
- **Step 3:** Commencing with the start of the next 24 period hold the temperature of the test chamber to M:+27°C, T:+32°C, H:+43°C, for a further 12 hours. Then lower the temperature to M:+10°C, T:+15°C, H:+25°C over a 3 hour period. Hold at M:+10°C, T:+15°C, H:+25°C for a further 9 hours. Next raise the ambient temperature to M:+27°C, T:+32°C, H:+43°C over a further 3 hour period. Hold at M:+27°C, T:+32°C, H:+43°C for a further 9 hours. Repeat this simulated day-night cycle for five complete 24 hour cycles in total.
- **Step 4:** At the end of the first 24 hour period remove a minimum of 1.6 kg of packs and not less than 2.4 kg per 50 litres of gross freezer volume of packs from the freezer compartment. These packs will not be returned to the freezer at this time.
- **Step 5:** Record compartment temperatures every minute for the whole test. Measure electricity consumption and the cooling system duty cycle over the same test duration and report energy consumption in kWh/day, the percentage on-time over each 24 test phase and graphically display on/off cycles.
- **Step 6:** At the end of this 24 hour period load [water-packs](#) which have been stabilized at +43°C. This loading replaces the packs removed in Step 4.
- **Step 7:** At the end of the next 24 hour period record each pack volume, location and condition (i.e. fully frozen or not fully frozen) per instructions in **Annex 1- Fully frozen [water-pack](#) determination**. Except for packs which are to be removed in Step 4, return packs to exact positions without delay.
- **Step 8:** Repeat steps 3 to 7 until five complete day-night cycles have been completed. If possible, packs removed in each repetition of Step 4 must include packs by rotation not previously removed. Record and report the maximum number and volume of fully frozen packs that can remain fully frozen at the end of the every night-time phase.
- **Step 9:** Review the data and calculate the MKT for each sensor in the vaccine storage compartment over the five day period. Record the highest and lowest temperatures reached during the test.
- **Acceptance criterion:** Vaccine storage compartment temperatures must remain within the [acceptable temperature range](#) throughout the test. The MKT of the worst-case sensor must not be outside the range +2°C to +8°C.

No standard set for the number of fully frozen and non-fully frozen packs at the end of each power off phase but results to be reported as the quantity and volume of stored frozen water-packs that can remain fully frozen at the end of testing over a five day period. No standard set for power consumption but report the energy consumption in kWh/day, the percentage on-time during the 5 day test time and graphically display on/off cycles.

- **Rejection criterion:** Failure to meet one or more of the acceptance criteria.

#### 5.3.7 Test 6: Holdover time:

- **Step 1:** For appliances without water-pack freezing, continue the Test 3 conditions. For combined appliances, continue the Test 4 conditions but with the water-pack freezing compartment empty.
- **Step 2:** Provide energy until the refrigerator and freezer temperatures have re-stabilized.
- **Step 3:** At the end of the next cooling circuit on cycle, switch off the energy supply. If the cooling circuit has already cycled off at this point record the elapsed time since the end of the previous on cycle (t).
- **Step 4:** Monitor the temperature of the vaccine load at one-minute intervals. At the moment when the warmest point in the load exceeds +8°C record the elapsed time since energy supply switched off and add this to the value 't' recorded in Step 3. Record the position of the warmest point.
- **Acceptance criterion:** A minimum of 4 hours at a continuous ambient temperature of +43°C.
- **Rejection criterion:** Failure to meet the minimum holdover period for which the appliance is rated.

#### 5.3.8 Test 7: Freeze protection classification:

- **Step 1:** At the end of Test 6, immediately switch on power to the appliance and monitor the temperature of the vaccine compartment at one-minute intervals.
- **Step 2:** Maintain power availability until the appliance cools down and the temperatures stabilize.

**Acceptance criteria:** To receive a **Grade A** for [freeze protection classification](#), the appliance's cool-down temperatures:

- Must not drop below 0°C for longer than 1 hour.
- Must not reach -0.5°C for any amount of time.
- Following any excursion below 0°C, within 2 hours the appliance must return to the [acceptable temperature range](#) (i.e., consistently between +2°C and +8°C).

**Rejection criterion:** Failure to maintain [acceptable temperature range](#) during cool-down and stabilization.

#### 5.3.9 Test 8: Door opening:

- **Step 1:** Continuing from Test 9, after an additional 1 hour of continuous power availability, open all compartment lids/doors of the appliance. This must include primary as well as secondary lids/doors, since some appliances have secondary lids/doors. Allow the compartment to stay fully open for 10 minutes.

- **Step 2:** Once 10 minutes have passed, close the lid/door and monitor temperatures of the vaccine compartment for at least 2 hours as the appliance cools down and internal temperatures stabilize.

**Acceptance criteria:** To receive a **Grade A** for [freeze protection classification](#), the appliance's cool-down temperatures:

- Must not drop below 0°C for longer than 1 hour.
- Must not reach -0.5°C for any amount of time.
- Following any excursion below 0°C, within 2 hours the appliance must return to the [acceptable temperature range](#) (i.e., consistently between +2°C and +8°C).

**Rejection criteria:** Failure to maintain [acceptable temperature range](#) during cool-down and stabilization.

#### 5.3.10 Test 9: Minimum rated ambient temperature:

- **Step 1:** Continuing from Test 8, stabilize the test chamber at +10°C or at a lower temperature specified by the manufacturer rounded up or down to the nearest 5°C<sup>4</sup>. At the same time, for combined appliances, stabilize the minimum specified [water-pack freezing capacity](#) load at the current ambient temperature<sup>5</sup>.
- **Step 2:** Load the appliance with simulated, pre-conditioned vaccine as described in **Annex 1**.
- **Step 3:** Switch the appliance on and stabilize the vaccine load temperature between +2°C and +8°C and the water-pack freezing compartment (if present) below -3°C. At the same time, for combined appliances, stabilize the minimum specified water-pack load at the current ambient temperature.
- **Step 4:** Load the stabilized water-packs (combined appliances only) and leave the appliance to run for 24 hours.
- **Step 5:** Run the appliance for a minimum of 72 hours at test chamber ambient of +10°C or at a lower temperature if specified by the manufacturer. Record temperatures every minute. At the end of every 24 hour period, remove the [water-packs](#) from the freezing compartment (if applicable) and check that they are fully frozen to the minimum [water-pack freezing capacity](#) established in Test 4. Return the packs to the freezer immediately.
- **Step 6:** After a minimum of 72 hours of operation determine which of the two conditions apply.
  - **Condition 1:** The vaccine load has remained within the +2°C to +8°C range and (in combined appliances only) [water-packs](#) are fully frozen as defined in Step 5. Conclude the testing.
  - **Condition 2:** The vaccine load has not remained within the +2°C to +8°C range and/or (in combined appliances only) [water-packs](#) are not frozen as defined in Step 5. Raise the temperature of the test chamber by 5°C or to a maximum of +10°C and repeat steps 1 to 5. Halt the test cycle if the appliance fails at +10°C.

<sup>4</sup> For example, if the manufacturer's rated minimum operating temperature for a temperate climate appliance is +3°C, start the test at +5°C. If no minimum temperature is given, start the test at +10°C.

<sup>5</sup> 'Minimum load' in this context is the gross volume of [water-packs](#) needed to produce the acceptable minimum mass of ice (1.6kg or 2.4kg) at the end of a night-time phase as established in Test 4.

- **Step 7:** Report and graphically display the test chamber ambient temperatures, appliance temperatures and condition of [water-packs](#) through the entire test starting with Step 1 through the completion of Step 6. If the appliance passes the testing report the [minimum rated ambient temperature](#).

**Acceptance criteria:** Record the lowest temperature increment at which the vaccine load temperature remains within the +2°C to +8°C range throughout the 24 hour cycle and the minimum [water-pack](#) load (if applicable) is fully frozen by the end of the cycle. This temperature is the [minimum rated ambient temperature](#) for the appliance<sup>6</sup> and this figure, if not 0°C or any multiple of 5°C, is then rounded up to the nearest 5°C and must be +10°C or lower. The result will be printed in the blue sector of the temperature zone symbol (see **E003/RF04.3 Annex 1**).

**Rejection criterion:** Failure to pass the test at a simulated temperature of +10°C or lower.

#### 5.4 Test criteria for qualification:

A final report must be issued after all testing is complete. The report of the tests must contain the following data and analyses:

- **Summary:** Conclusions and recommendations, including confirmation of the temperature zone(s) for which the appliance is suitable.
- **Test 1:** Comments on samples received, tabulated data on the type-examination test, certifications, and relevant photographs.
- **Test 2:** Results of cool-down test, including hours to initial stabilization, temperature and energy graphs.
- **Test 3:** Results of stable running and energy consumption test, including temperature and energy graphs.
- **Test 4:** If applicable, results of water-pack freezing capacity, storage compartment capacity test, including temperature and energy graphs.
- **Test 5:** Results of day/night and freezer storage capacity tests, including MKT analysis, temperature and energy graphs.
- **Test 6:** Results of holdover time test, including temperature graphs.
- **Test 7:** Results of the freeze protection classification test, including temperature graphs. Refer to **Annex 5** for methodology for freeze protection analysis and grading.
- **Test 8:** Results of the door opening test, including temperature graphs.
- **Test 9:** Results of minimum rated ambient temperature test, including temperature graphs.
- **Excursion analysis:** MKT excursion analysis based on test data in accordance with the [acceptable temperature range](#) definition.
- **Annexes:** Description of the test apparatus. Test chamber temperature records. Copy of reference thermometer calibration certificate(s). Diagrams showing the location and identification codes for temperature sensors, clearly distinguishing between sensors measuring vaccine, water-pack, freezer and evaporator temperatures. Additional supporting documentation requested and received from the [Legal Manufacturer](#) or [Reseller](#) during the course of the type-testing.

---

<sup>6</sup> Although the test chamber may reach -15°C during the test, the [minimum rated ambient temperature](#) will never be below -10°C.



## 6. Quality control checklist

### 6.1 Quality control standards:

All testing and reporting must be carried out in accordance with the requirements of ISO 17025:2005 or later edition.

### 6.2 Quality control checklist:

An on-site inspection of the manufacturing plant is not required.

### 6.3 Quality control evaluation:

Not required.

## 7. Pre-qualification evaluation

An appliance will qualify for inclusion on the register of PQS pre-qualified ice-lined refrigerator appliance in accordance with WHO procedures provided the final report indicates full conformity with the requirements of specification **E003/RF04.3**.

## 8. Modified appliances

The [Legal Manufacturer](#) or [Reseller](#) must notify WHO [in writing](#) of any changes which affect the performance of the appliance. WHO will carry out a desk evaluation of the reported change(s). If any change is deemed adversely to affect the performance of the appliance, WHO may request full or partial re-verification based on the test procedures described in this document.



## Annex 1 – General test conditions

The following conditions are applicable to all refrigerator and freezer tests.

### Test conditions:

- Carry out tests in a test chamber in which temperatures can be controlled to  $\pm 1^{\circ}\text{C}$  and humidity within the range of 45% to 75% unless otherwise stated below. Measure test chamber temperatures in accordance with IEC 62552, clause 8.2.
- Maximum test chamber temperatures of H:+43°C is required for the tests.
- Minimum test chamber temperatures down to -15°C may be required for the [minimum ambient temperature rating](#) test. The actual minimum required for a specific appliance should be discussed with the appliance manufacturer before the test commences.
- Temperatures within the appliance must be continuously monitored to an accuracy of  $\pm 0.5^{\circ}\text{C}$  without the presence of the sensors influencing the test in any way. Thermocouples that are sealed within the appliance are most commonly used. Up to 16 simultaneous temperature measurements may be required for a single appliance. The suggested temperature sensor locations are shown in [Annex 2](#). See [Annex 3](#) for temperature sensor specifications.
- Position the test appliance in the test chamber with its back face 50 mm clear of one of the chamber walls. Ensure that it is accurately levelled.

### Stabilization times:

Initial stabilization is accomplished when the appliance demonstrates all of the following:

- The thermal storage has been cooled for a time period no less than the cool down time period stated in the instructions provided by the manufacturer. (e.g. if instructions state cool down time is 3 days then at least a 3 day cool down test is required); and
- The internal temperatures in the vaccine storage compartment are within the [acceptable temperature range](#); and
- The cooling system has exhibited consistent on/off operation for the final two days of this test (e.g. the same number of on/off cycles per day for the final two days).

Before measuring the performance of a refrigerator or freezer under normal running conditions, internal temperature conditions in the [vaccine storage compartment](#) must be stable. This is normally assumed to have occurred when either:

- The thermostat has been cycling for 24 hours, or
- The temperature at each of corresponding points during successive operating cycles varies by less than  $\pm 1^{\circ}\text{C}$  and there is no marked trend away from the mean temperature at that point over 24 hours.

### Vaccine net storage capacity measurement:

- Measure [vaccine storage capacity](#) using cardboard boxes, plastic foam or wooden blocks, 100 x 100 x 100 mm, 100 x 100 x 50 mm, and 50 x 50 x 50 mm.

- Fill the appliance up to the maximum loading line recommended by the manufacturer.
- Where baskets and shelves are supplied, these should be used to hold the dummy load. Do not place any boxes outside the zone designated by the manufacturer for vaccine storage.
- Do not place the dummy load in the fast freeze compartments of vaccine freezers.

#### **Recording temperatures:**

- Test appliances, either loaded or empty, as described above in the verification protocol.
- Take temperature readings once per minute.

#### **Sensor placement:**

- Place sensors in contact with the surfaces of the [vaccine storage compartment](#) and at the centre of the vaccine load as well as at other positions which are likely to experience extremes of temperature. Such positions might be near door seals or where air circulation is restricted by the appliance design. See the **Annex 2** sensor position diagrams and notes.
- For non-Grade A appliances and where vaccine storage baskets are required to avoid [freezing temperatures](#), fix sensors within the volume(s) defined by the internal faces of the basket(s).
- Fix the sensors in position so that they cannot be displaced during the course of the tests. Sensors may be fixed in position using thin rigid wire, tape or similar materials which do not affect the thermal performance of the appliance.
- After initial setup, do not alter the position of sensors during subsequent tests.
- Monitor all sensors so that an overall picture of the temperature distribution can be obtained.

#### **Dummy vaccine load:**

Make up a dummy vaccine load<sup>7</sup> using partially filled [water-packs](#).

- Measure the chosen water-packs to establish their nominal unit volume in litres (length x width x thickness in cm/1000).
- Select the number of empty [water-packs](#) required to build a dummy load whose nominal volume is equal to the measured [vaccine net storage capacity](#) in litres divided by five,  $\pm 5\%$ .
- Partially fill the [water-packs](#) with equal volumes of water so that the mass of the load is equal to the nominal load volume x 0.4 kg (0.4 kg per litre). Pre-condition the dummy load at +8°C and place in the appliance as follows so that it does not interfere with the sensor positions already established:

*Front-opening appliances:*

- Stack the partially filled [water-packs](#) evenly on the shelves designated for vaccine storage.

---

<sup>7</sup> The dummy load described below is intended to approximate the minimum vaccine load in a well-managed refrigerator holding a 25% safety stock.

*Top-opening refrigerators:*

- Stack the partially filled [water-packs](#) evenly on the bottom of baskets supplied for vaccine storage.
- If baskets are not required to keep vaccine away from the base and walls of the appliance, stack the partially filled [water-packs](#) evenly on the base of the appliance.

*Top-opening freezers:*

- Stack the partially filled [water-packs](#) evenly on the base of the appliance.

**Water-packs:**

Tests which require water-packs must use 0.3, 0.4 or 0.6 litre water-packs conforming to PQS specification **E005/IP01**.

**Dual compressor or multiple cooling circuit appliances:**

Both compressors should be switched on during all tests.

**Multi-fuel and multi-function appliances:**



- Multi-fuel appliance (typically absorption refrigerators or freezers) will be lengthy and costly to test, so a decision on which options should be tested will be made by WHO on a case by case basis.
- In the case of appliances which can be run either as a freezer or as a refrigerator, the first set of tests should test the refrigerator function and the second set should test the freezer function.

**Annex 2 – Temperature sensor positions**

Approximate sensor positions are indicated by the **Annex 2** figures. Except for ambient sensors placed centrally in a compartment the surface sensors are positioned in direct contact with the [vaccine storage compartment](#). If baskets are used to define the [vaccine storage compartment](#), all sensors are to be located inside the basket(s) and the surface sensors are to be in contact with the basket material and as shown in the **Annex 2** figures.

The surface sensors that are to be placed in direct contact with the walls of the vaccine storage compartment are not to be inserted into brass or tin-covered copper mass, as required in the previous version of this protocol. These surface sensors must be directly in contact with the walls of the vaccine storage compartment. However, the ambient sensors that are placed in more central locations in the vaccine storage compartment are to remain in a brass- or tin-covered copper mass.

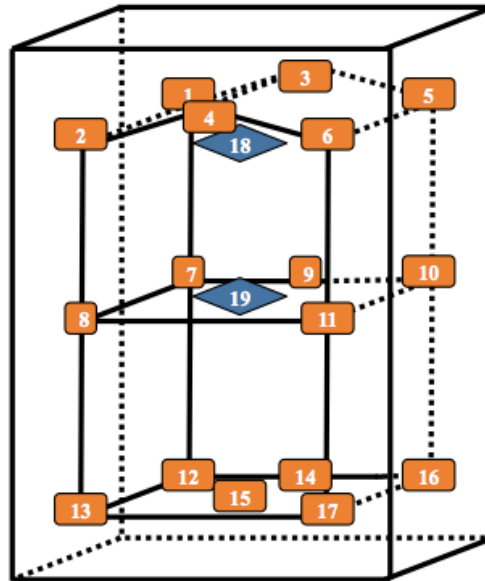
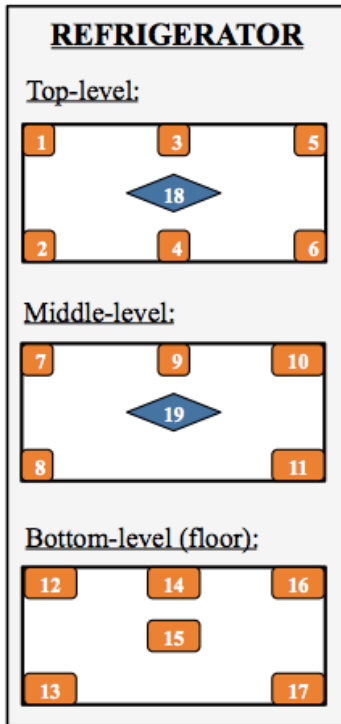

## UPRIGHT COMPARTMENT

-  Surface sensors
-  Ambient sensors



All sensors are to be positioned according to this layout and in direct contact with compartment surfaces.

## UPRIGHT COMPARTMENT – WITH FREEZER

-  Surface sensors
-  Ambient sensors

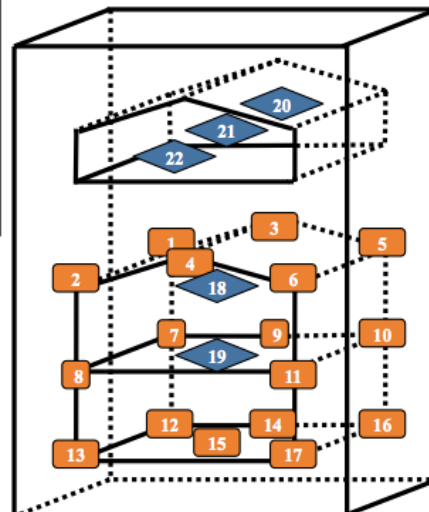
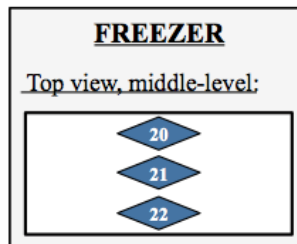
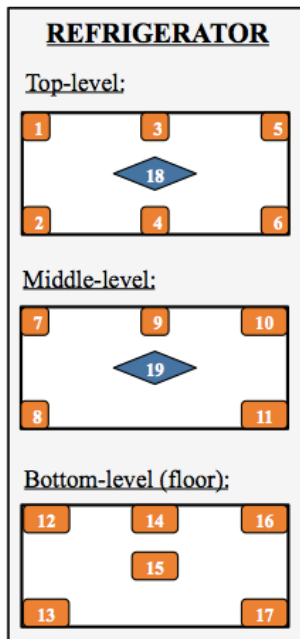

All sensors are to be positioned according to this layout and in direct contact with compartment surfaces.

### CHEST COMPARTMENT – NO STEP

- 17 Surface sensors
- 2 Ambient sensors

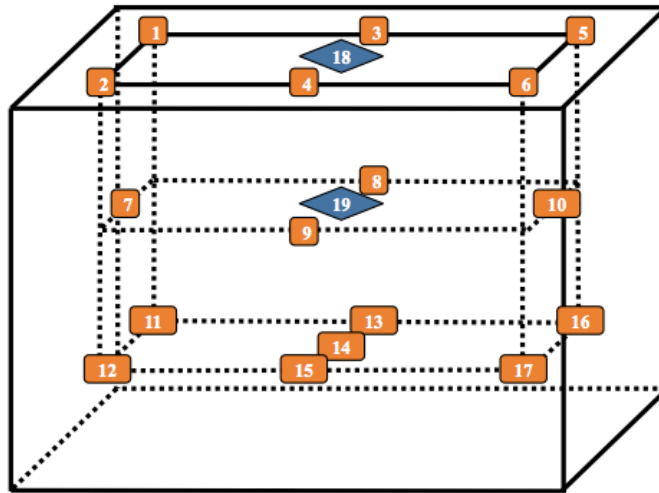
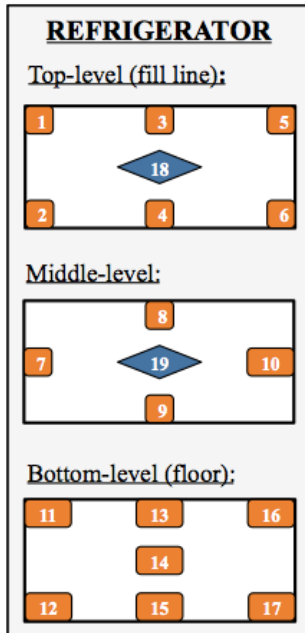

All sensors are to be positioned according to this layout and in direct contact with compartment surfaces.

### CHEST COMPARTMENT – WITH STEP

- 17 Surface sensors
- 2 Ambient sensors

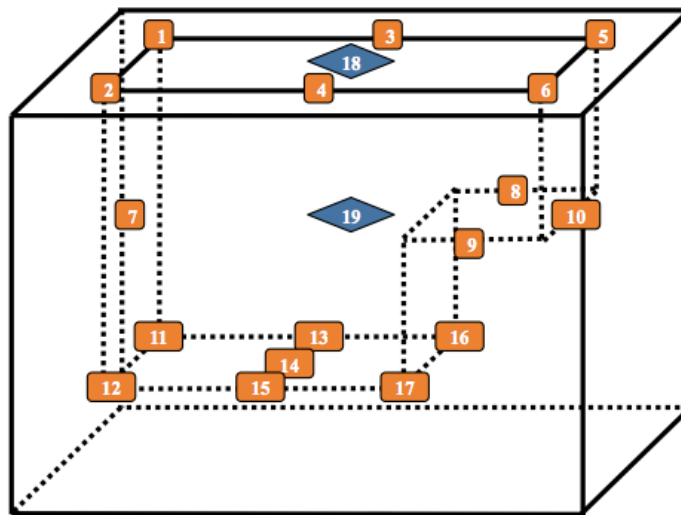
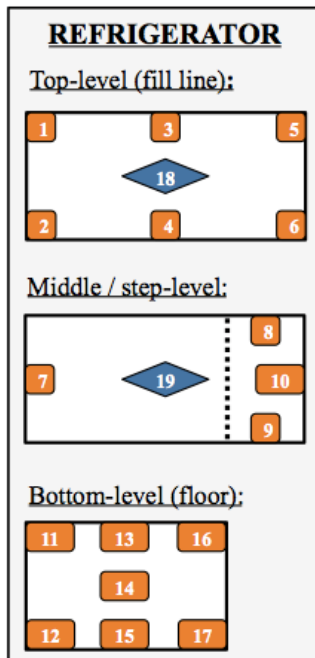

All sensors are to be positioned according to this layout and in direct contact with compartment surfaces.

### CHEST COMPARTMENT – WITH FREEZER

- 17 Surface sensors
- 5 Ambient sensors

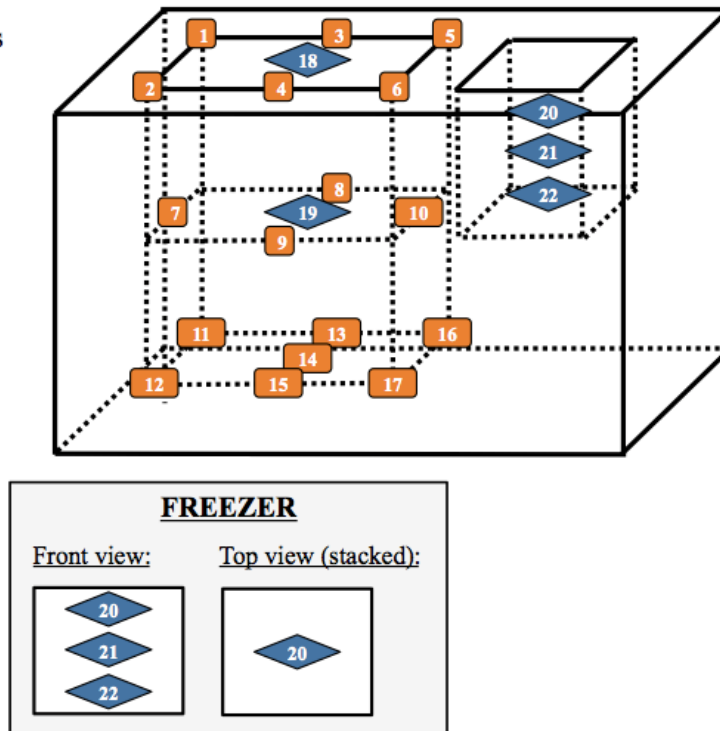
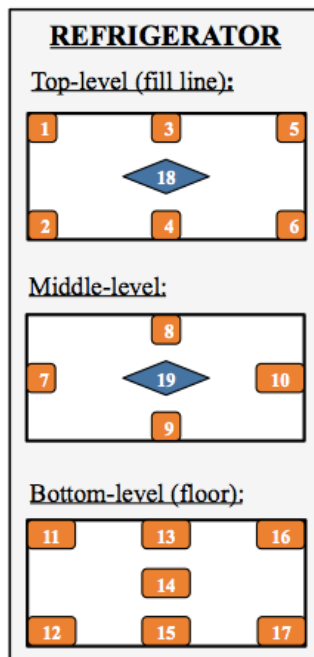

### CYLINDRICAL CHEST COMPARTMENT

- 13 Wall sensors
- 2 Ambient sensors

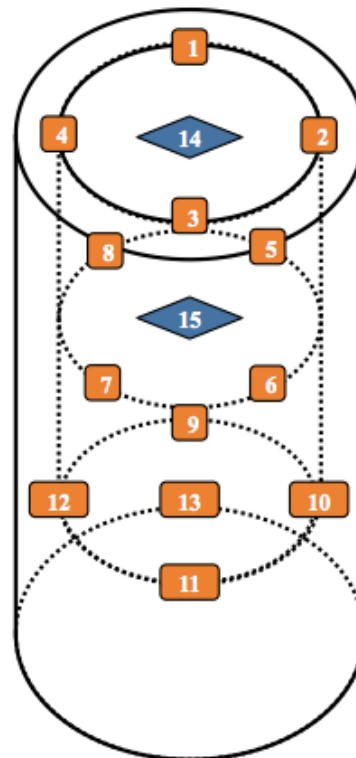
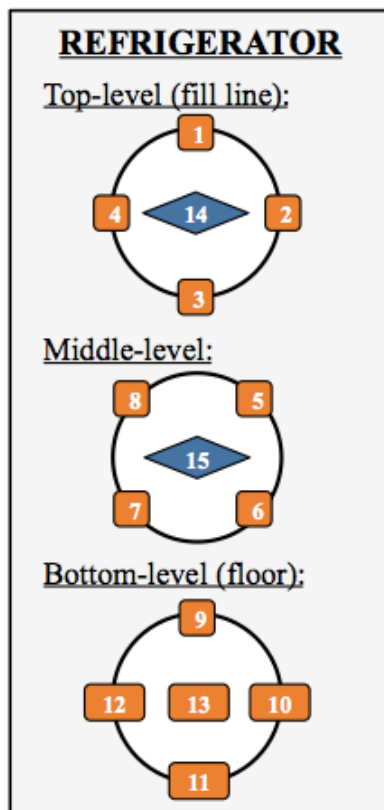

### Annex 3 – Temperature sensor specification

Surface sensors in contact with the vaccine compartment surfaces must comply with IEC 62552, clause 8.7.1 with probe accurate to  $\pm 0.5^{\circ}\text{C}$  but are not to be inserted into brass or tin-covered copper mass of  $25\text{ g} \pm 5\%$ . Ambient sensors not in contact with the vaccine storage compartment are to comply with IEC 62552, clause 8.7.1 with sensor, accurate to  $\pm 0.5^{\circ}\text{C}$ , inserted into brass or tin-covered copper mass of  $25\text{ g} \pm 5\%$  and of minimum external area (diameter = height = about 15.2 mm).

### Annex 4 – Methodology for measurement of ice production

The following tests are used to determine whether a [water-pack](#) is fully frozen, partially frozen, or unfrozen. While the assessment is not 100% accurate, misclassifications are usually conservative in nature: [water-packs](#) that are fully frozen are sometimes classified as partially frozen rather than partially frozen [water-packs](#) being classified as fully frozen. A fully frozen [water-pack](#) contains only ice. A partially frozen [water-pack](#) contains both ice and water. An unfrozen [water-pack](#) contains only water

Perform the all of the following tests on the [water-pack](#):

- Shake test - Shake the [water-pack](#) while holding the [water-pack](#) near the assessor's ear. If the sound of water sloshing in the [water-pack](#) is heard, then the [water-pack](#) fails the shake test.
- Tilt test – Tilt the [water-pack](#) back and forth while looking for the movement of air or water in the [water-pack](#). If the movement of air or water is observed, then the [water-pack](#) fails the tilt test.
- Bulge test – Water expands when it freezes. Examine the [water-pack](#) for localized bulging near the centreline of the [water-pack](#) when viewing the [water-pack](#) from the side. If localized bulging is not present, then the [water-pack](#) fails the bulge test.
- Classify the [water-pack](#) as follows:
  - If the [water-pack](#) passes all three tests, then the [water-pack](#) is fully frozen.
  - If the [water-pack](#) fails one or more tests, then the [water-pack](#) is partially frozen or unfrozen and fails the test.

### Annex 5 – Methodology for freeze protection analysis and grading

- All data collected and interventions implemented, with the exception of data from Test 2 cool-down, must be evaluated to assign a freeze protection grade according to the definition of [freezing temperatures](#) and the below intervention chart:

User-Intervention	Evaluation Criteria	Result
Basket storage	Any need to utilize baskets to protect vaccines from freezing.	add 1 user-intervention
Compartment covers	Any need to utilize vaccine compartment covers to protect vaccines from freezing.	add 1 user-intervention
Knob adjustment	Any adjustment of temperature knob or fuel regulator required to protect vaccines from freezing.	add 1 user-intervention



Wick adjustment	Any required adjustment of flame wick to operate appliance and/or protect vaccines from freezing.	add 1 user-intervention
-----------------	---	-------------------------

**NOTE:** This list of interventions is representative and does not include all possible user-interventions.

- Freeze protection grading criterion: The refrigerator's grade must be evaluated based on the number of user-intervention required to maintain safe storage within the 2-8°C compartment temperature range.
  - Grade A, user-independent freeze protection (UIFP): zero (0) interventions required.
  - Grade B, user-dependent freeze protection (UDFP): one (1) user-intervention required.
  - Grade C, user-dependent freeze protection (UDFP): greater than one (>1) user-interventions required.
- If at any point during testing, the appliance fails to meet the criteria for "A" grade freeze protection, the testing must be stopped, a manufacturer prescribed intervention implemented and the testing restarted from Test 2. These interventions must be implemented one at a time so as to differentiate between single-intervention "B" grades and multi-intervention "C" grades.

<b>Revision history (after April 26, 2017 revisions):</b>			
<b>Date</b>	<b>Change summary</b>	<b>Reason for change</b>	<b>Approved</b>