

March 2020

Severe Acute Respiratory Infections Treatment Centre

Practical manual to set up and manage a SARI treatment centre and
a SARI screening facility in health care facilities

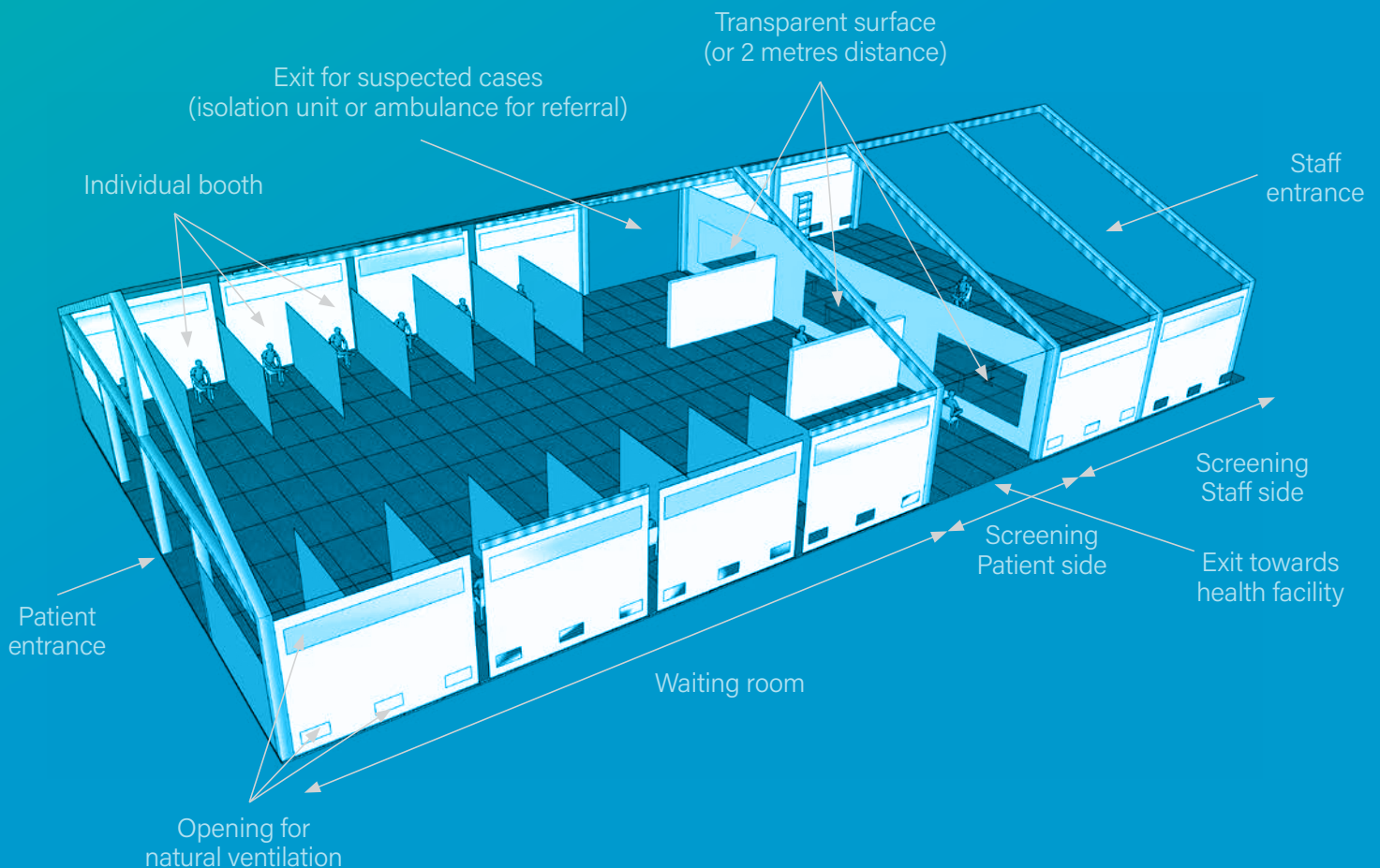

March 2020

Severe Acute Respiratory Infections Treatment Centre

Practical manual to set up and manage a SARI treatment centre and
a SARI screening facility in health care facilities

WHO/2019-nCoV/SARI_treatment_center/2020.1

© World Health Organization 2020

Some rights reserved. This work is available under the Creative Commons Attribution-NonCommercial-ShareAlike 3.0 IGO licence (CC BY-NC-SA 3.0 IGO; <https://creativecommons.org/licenses/by-nc-sa/3.0/igo>).

Under the terms of this licence, you may copy, redistribute and adapt the work for non-commercial purposes, provided the work is appropriately cited, as indicated below. In any use of this work, there should be no suggestion that WHO endorses any specific organization, products or services. The use of the WHO logo is not permitted. If you adapt the work, then you must license your work under the same or equivalent Creative Commons licence. If you create a translation of this work, you should add the following disclaimer along with the suggested citation: "This translation was not created by the World Health Organization (WHO). WHO is not responsible for the content or accuracy of this translation. The original English edition shall be the binding and authentic edition".

Any mediation relating to disputes arising under the licence shall be conducted in accordance with the mediation rules of the World Intellectual Property Organization.

Suggested citation. Severe acute respiratory infections treatment centre: practical manual to set up and manage a SARI treatment centre and SARI screening facility in health care facilities. Geneva: World Health Organization; 2020 (WHO/2019-nCoV/SARI_treatment_center/2020.1). Licence: CC BY-NC-SA 3.0 IGO.

Cataloguing-in-Publication (CIP) data. CIP data are available at <http://apps.who.int/iris>.

Sales, rights and licensing. To purchase WHO publications, see <http://apps.who.int/bookorders>. To submit requests for commercial use and queries on rights and licensing, see <http://www.who.int/about/licensing>.

Third-party materials. If you wish to reuse material from this work that is attributed to a third party, such as tables, figures or images, it is your responsibility to determine whether permission is needed for that reuse and to obtain permission from the copyright holder. The risk of claims resulting from infringement of any third-party-owned component in the work rests solely with the user.

General disclaimers. The designations employed and the presentation of the material in this publication do not imply the expression of any opinion whatsoever on the part of WHO concerning the legal status of any country, territory, city or area or of its authorities, or concerning the delimitation of its frontiers or boundaries. Dotted and dashed lines on maps represent approximate border lines for which there may not yet be full agreement.

The mention of specific companies or of certain manufacturers' products does not imply that they are endorsed or recommended by WHO in preference to others of a similar nature that are not mentioned. Errors and omissions excepted, the names of proprietary products are distinguished by initial capital letters.

All reasonable precautions have been taken by WHO to verify the information contained in this publication. However, the published material is being distributed without warranty of any kind, either expressed or implied. The responsibility for the interpretation and use of the material lies with the reader. In no event shall WHO be liable for damages arising from its use.

Editing and design by Inís Communication – www.iniscommunication.com

CONTENTS

Foreword.....	viii
Acknowledgements.....	ix
Abbreviations.....	x
Introduction.....	1
Acute respiratory infections.....	1
Coronaviruses.....	1
Purpose, scope and audience of this document.....	2
Infection prevention and control during health care when COVID-19 is suspected.....	3
Ensuring triage, early recognition and source control.....	3
Application of standard precautions for all patients.....	3
Contact and droplet precautions for people with suspected COVID-19.....	4
Airborne precautions for aerosol-generating procedures for people with suspected novel coronavirus infection.....	4
Modes of transmission definitions.....	5
Managing the epidemic.....	6
Epidemic phases and stages of intervention.....	6
Anticipation.....	6
Early detection.....	7
Containment.....	7
Scenarios of transmission.....	7
Scenario and strategic priorities.....	8
Key clinical and IPC activities for different transmission scenarios.....	10
Ventilation.....	12
Natural ventilation.....	12

Mechanical ventilation.....	14
Hybrid or mixed-mode ventilation.....	14
Advantages and disadvantages of different types of hospital ventilation system: summary.....	15
Proposed hybrid ventilation system for severe and critical wards.....	15
Extraction fan technical requirements.....	16
Installing an air extractor in a patient's room.....	17
Exhausted air.....	18
HEPA filter.....	18
Portable air filtration systems.....	19
Ultraviolet germicidal irradiation.....	20
UVC lamp requirements.....	21
UV lamp installation.....	22
UV light exposure risk.....	22
Testing the ventilation/exhausted air systems.....	23
Proposed ventilation system and exhausted air treatment by area or service: summary.....	23
Description of proposed exhausted air treatment system.....	24
Screening for health-care facilities.....	25
Identification, selection and survey of screening sites.....	25
Location criteria.....	25
Ground characteristics.....	25
Meteorological characteristics.....	25
Existing resources.....	26
Screening basic layout principles.....	26
Screening in new health-care facilities.....	26
Waiting room.....	28
Isolation room.....	28
Establishing a screening area in a tent.....	28
SARI treatment centre.....	32
Site identification, selection and survey.....	32
Location criteria.....	32
Ground characteristics.....	32
Meteorological characteristics.....	32
Existing resources.....	32

Basic layout	33
Minimum requirements for converting an existing building into a severe acute respiratory infection treatment centre	36
Recommended characteristics for selecting finishes and furniture	36
Layout	37
Facilities and services	44
Staff entrance and changing room	44
Triage area	44
Reception	45
Waiting room	45
Sampling room	45
Discharge room	45
Short-stay mild and moderate wards	46
Severe and critical wards, and intensive care units	46
Use of transparent surfaces	47
Establishing a SARI treatment centre in a tent	49
Community facility	51
Surge capacity	52
Implementation of infection prevention and control measures	54
Use of personal protective equipment	54
Surface cleaning and disinfection, materials and equipment for infection prevention and control at the facility level	56
Cleaning staff	56
Cleaning supplies and equipment	57
Environmental cleaning services area	58
General environmental cleaning techniques	59
Conduct visual preliminary site assessment	59
Proceed from cleaner to dirtier	59
Proceed from high to low (top to bottom)	59
Proceed in a methodical, systematic manner	59
Environmental surface cleaning and disinfection	60
Linen management	60
Cleaning and disinfection of biomedical devices	61
Management of dead bodies	61
Laboratory equipment and consumables	63

Water supply	64
Water quality	64
Water quantity	64
Waste zone	65
Wastewater and faecal waste	65
Excreta management	65
Energy	68
Electrical standard	68
Electrical panel	68
Plugs	69
Junctions	69
Cable protection	69
Exiting of buried cables	69
Other enclosures	70
Earth connection	70
Identification of electrical components	71
Equipment: quality and usage requirements	71
Identification rules for a coronavirus centre	72
Choosing the correct equipment	72
Energy consumption	73
Implementation of electrical project	74
Building equipment and power requirements	75
References	76

Annex 1: How to perform a particulate respirator seal check	79
Annex 2: Donning and doffing personal protective equipment	80
Annex 3: Severe acute respiratory infection treatment centre layout	81
Annex 4: Severe acute respiratory infection treatment centre legend	82
Annex 5: Severe acute respiratory infection treatment centre measures	83
Annex 6: Axonometric view of severe acute respiratory infection treatment centre with roof	84
Annex 7: Axonometric view of severe acute respiratory infection treatment centre without roof	85
Annex 8: Short-stay ward for mild and moderate cases	86
Annex 9: Individual rooms and wards in severe acute respiratory infection treatment centre	87
Annex 10: Budget estimation and chronogram	88
Annex 11: Furniture and consumables required for severe acute respiratory infection treatment centre	92
Annex 12: Personal protective equipment module for severe acute respiratory infection treatment centre based on 100 patients	95
Annex 13: Work uniform module for severe acute respiratory infection treatment centre based on 40 staff members per shift	96
Annex 14: Biomedical devices needed for severe acute respiratory infection treatment centre	97
Annex 15: Severe acute respiratory treatment centre extension plan (cohorting approach)	100
Annex 16: Screening for health facilities description	101
Annex 17: Screening for health facilities measures	102
Annex 18: Screening for health facilities legend	103

Foreword

This is the first edition of the practical manual to set up and manage a severe acute respiratory infection (SARI) treatment centre and a SARI screening facility in health-care facilities. The document has been developed to meet the operational needs emerging with the COVID-19 pandemic.

The information presented has been compiled to provide the reader with a thorough understanding of the principles driving the design process of COVID-19 screening areas and SARI treatment centres for health-care facilities. The current manual incorporates the latest information available at the date of publication.

Various practical tools are presented in the annexes and more technical guidance are available at: <https://www.who.int/emergencies/diseases/novel-coronavirus-2019/technical-guidance>

This document is intended for health managers and planners, architects, engineers, logistics, water and sanitation staff, clinical and nursing staff, carers and other health-care providers, as well as health promoters.

The authors welcome any remarks or critical comments from those using this guide, so as to allow revision in keeping with the realities of working in the field.

Comments should be addressed to:

World Health Organization
Avenue Appia 20
1202 Geneva, Switzerland
Email: oslhealthtech@who.int

Acknowledgements

Title and name	Position/Department	Organization or institution
Kamal Ait-Ikhlef	Technical Officer Logistics (OSL)	World Health Organization
Dr April Baller	Infection Prevention and Control Expert (WPE/CRS/HCR)	World Health Organization
David Manuel Cuenca	Logistics and Operations Officer (OSL/AFRO)	World Health Organization
Antoine Delaitre	Technical Officer Logistics (OSL)	World Health Organization
Dr Janet Victoria Diaz	Clinical Network Leader (WPE/CRS/HCR)	World Health Organization
Dr Jorge Durand	Technical Expert Consultant (EMT)	World Health Organization
Luca Fontana	Environmental Toxicologist/Epidemiologist (OSL)	World Health Organization
Guillaume Gueyras	Technical Officer Logistics (OSL)	World Health Organization
Dr Belinda Louise Herring	Technical Laboratory Expert (EMP/AFRO)	World Health Organization
Raul Emilio Iraheta	Technical Laboratory Expert Consultant (OSL)	World Health Organization
Dr Maria Van Kerkhove	Scientist (WPE/GIH/EZD)	World Health Organization
Nick Lobel-Weiss	Project Director, UK Emergency Medical Team (UK-EMT)	Department for International Development (DFID)
Francis Roosevelt Mulemba	Technical Officer Logistics (OSL)	World Health Organization
Paul Molinaro	Chief (SHO/OSL)	World Health Organization
Dr Maria Clara Padoveze Fonseca Barbosa	Infection Prevention and Control Expert (UHL/IHS/QOC)	World Health Organization
Ms Ana Paula Coutinho Rehse	Technical Officer, Infection Prevention and Control, Health Emergencies Programme, Division of Health Emergencies and Communicable Diseases	WHO Regional Office for Europe
Jordi Sacristan Llobet	Technical Officer Logistics (OSL)	World Health Organization
Dr Flavio Salio	EMT Team Lead (WPE/GIH)	World Health Organization
Gerald Schwinte	Technical Officer Logistics (OSL)	World Health Organization
Prof. Mehtar Shaheen	Professor Infection Control (retired); Chair Education Working Group (ICAN)	Infection Control Africa Network
Anna Silenzi	Architect	World Health Organization
Frederic Urlep	Technical Officer Logistics (OSL)	World Health Organization
Laura Alejandra Velez Ruiz Gaitan	Medical Devices Consultant (OSL)	World Health Organization
Jean-Pierre Veyrenche	Operations Support/Water and Sanitation Expert	Independent Consultant
WHO Health Emergencies Programme (WHE) Experts Ad-Hoc Advisory Panel for Infection Prevention and Control (IPC) Preparedness, Readiness and Response to COVID-19		

Abbreviations

CDC	United States Centers for Disease Control and Prevention
CoV	coronaviruses
COVID-19	coronavirus disease 2019
HEPA	high-efficiency particulate air
IPC	infection prevention and control
MERS-CoV	Middle East respiratory syndrome
nCoV	novel coronavirus
NIOSH	National Institute for Occupational Safety and Health
PCR	polymerase chain reaction
PPE	personal protective equipment
SARI	severe acute respiratory infection
SARS-CoV	severe acute respiratory syndrome coronavirus
SARS-CoV2	severe acute respiratory syndrome coronavirus 2
UV	ultraviolet
UVGI	ultraviolet germicidal irradiation
WHO	World Health Organization

Introduction

Acute respiratory infections

Acute respiratory infections are the leading cause of morbidity and mortality from infectious disease in the world. Almost 4 million people die from acute respiratory infections each year, with 98% of these deaths due to lower respiratory tract infections. Mortality rates are particularly high in infants, children and elderly people, especially in low- and middle-income countries. Acute respiratory infections are one of the most frequent causes of consultation or admission to health-care facilities, particularly in paediatric services (1).

Bacteria are a major cause of lower respiratory tract infections, with *Streptococcus pneumoniae* being the most common cause of bacterial community-acquired pneumonia in many countries. Most acute respiratory infections, however, are caused by viruses or are a mix of viral-bacterial infections. Acute respiratory infections that have epidemic or pandemic potential and may pose a public health risk warrant special precautions and preparedness (1).

The incidence, distribution and outcome of disease of specific acute respiratory infections vary according to several factors, including:

- environmental conditions, such as air pollutants, household crowding, humidity, hygiene, season and temperature;
- availability and effectiveness of medical care and infection prevention and control (IPC) measures to contain spread, such as vaccines, access to health-care facilities, and isolation capacity;
- host factors, such as age, cigarette-smoking, host ability to transmit infection, immune status, nutritional status, prior or concurrent infection with other pathogens, and underlying medical conditions;
- pathogenic characteristics, such as modes of transmission, transmissibility, virulence factors (e.g. genes encoding toxins) and microbial load (inoculum size) (1).

Coronaviruses

Coronaviruses (CoV) are a large family of viruses that cause illness ranging from the common cold to more severe diseases such as Middle East respiratory syndrome (MERS-CoV) and severe acute respiratory syndrome (SARS-CoV). A novel coronavirus (nCoV) is a new strain that has not previously been identified in humans. Coronaviruses are zoonotic, meaning they are transmitted between animals and people (2). Detailed investigations found that SARS-CoV was transmitted from civet cats to humans, and MERS-CoV from dromedary camels to humans. Several known coronaviruses are circulating in animals that have not yet infected humans. Common signs of infection include respiratory symptoms, fever, cough, shortness of breath and breathing difficulties. In more severe cases, infection can cause pneumonia, severe acute respiratory syndrome, kidney failure and death (2).

Purpose, scope and audience of this document

This document provides recommendations, technical guidance, standards and minimum requirements for setting up and operating severe acute respiratory infection (SARI) treatment centres in low- and middle-income countries and limited-resource settings, including the standards needed to repurpose an existing building into a SARI treatment centre, and specifically for acute respiratory infections that have the potential for rapid spread and may cause epidemics or pandemics. Some of the epidemic-prone acute respiratory infections may constitute a global public health emergency. According to the International Health Regulations published in 2005 (3), the respiratory disease events that may constitute a public health emergency of international concern include:

- severe acute respiratory syndrome, such as MERS-CoV, SARS-CoV or severe acute respiratory syndrome coronavirus 2 (SARS-CoV2);
- human influenza caused by a new subtype, including human episodes of avian influenza;
- pneumonic plague;
- novel acute respiratory infections that can cause large-scale outbreaks or outbreaks with high morbidity and mortality.

This document recommends the situations in which the building of a SARI treatment centre is indicated through defined thresholds, such as number of cases beyond the capacity of the health-care system or inadequate installation of health facilities.

This document is for use by health managers and planners, architects, engineers, logistics staff, water and sanitation staff, clinical and nursing staff, carers and other health-care providers, and health promoters. It can be used to:

- develop specific national standards relevant to SARI outbreak preparedness, readiness and response in different contexts;
- support the application of national standards and set specific targets in specific SARI treatment centre settings;
- assess the situation regarding environmental health and engineering standards in existing SARI treatment centres to evaluate the extent to which they may fall short of national plans and local targets;
- plan and carry out the required improvements;
- ensure the construction of new SARI treatment centres is of acceptable quality;
- prepare and implement comprehensive and realistic action plans so acceptable conditions are achieved and maintained.

This document deals with SARI treatment centre design and flow, water supply (quality, quantity, access), excreta disposal, health-care waste management, cleaning, building design (including ventilation), construction and management, and hygiene. It is designed primarily for use in health-care settings in precarious situations and in situations where simple and affordable measures can improve hygiene and health significantly.

Infection prevention and control during health care when COVID-19 is suspected

IPC strategies to prevent or limit infection transmission in health-care settings include the following (4):

- early recognition and source control;
- application of standard precautions for all patients, regardless of suspected or known infection;
- implementation of empirical additional precautions (droplet, contact and, whenever applicable, airborne precautions) for people suspected of being infected;
- administrative controls;
- environmental and engineering controls.

Ensuring triage, early recognition and source control

Clinical triage includes a system for assessing all patients at admission, allowing early recognition of possible 2019-nCoV infection and immediate isolation of people with suspected 2019 coronavirus disease (COVID-19) in an area separate from other patients (source control) (4).

Application of standard precautions for all patients

Standard precautions include hand and respiratory hygiene, the use of appropriate personal protective equipment (PPE) according to risk assessment, injection safety practices, safe waste management, proper linens management, environmental cleaning, and sterilization of patient care equipment.

Respiratory hygiene measures include:

- ensuring all patients cover their nose and mouth with a tissue or elbow when coughing or sneezing;
- offering a medical mask to patients with suspected 2019-nCoV infection while they are in waiting or public areas or in cohorting rooms;
- performing continual hand hygiene according to “my five moments for hand hygiene” (5) and after contact with respiratory secretions.

Health-care workers should apply the World Health Organization (WHO) “my five moments for hand hygiene” approach before touching a patient, before performing any clean or aseptic procedure, after exposure to body fluids, after touching a patient, and after touching a patient’s surroundings (5):

- Hand hygiene includes either the use of an alcohol-based hand rub product or washing with soap and water.
- Alcohol-based hand rubs are the preferred option if hands are not visibly soiled.
- Hands should be washed with soap and water whenever they are visibly soiled.

The rational (6), correct and consistent use of PPE helps to reduce the spread of pathogens. The effectiveness of PPE strongly depends on adequate and regular supplies, adequate staff training, appropriate hand hygiene, and specifically appropriate human behaviour (1,5,7).

It is important to ensure environmental cleaning and disinfection procedures are followed consistently and correctly. Thoroughly cleaning environmental surfaces with water and detergent and applying commonly used hospital-level disinfectants such as sodium hypochlorite are effective and sufficient procedures (8). Consider emphasizing regular cleaning of high-contact areas such as door handles, benches and gates.

Contact and droplet precautions for people with suspected COVID-19

- In addition to standard precautions, all individuals, including family members, visitors and health-care workers, should apply contact and droplet precautions.
- Patients should be placed in adequately ventilated single rooms if possible. For naturally ventilated general ward rooms, this is considered to be 60 litres per second per person.
- When single rooms are not available, people suspected of having COVID-19 should be cohorted together.
- Do not cohort people with confirmed COVID-19 with people with suspected COVID-19.
- Do not cohort people with respiratory infections caused by other pathogens.
- Place beds at least 2 m apart.
- Where possible, cohort health-care workers to care exclusively for people with COVID-19 to reduce the risk of transmission due to inadvertent infection control breaches.
- Use medical masks.
- Use eye and facial protection (goggles, face shield).
- Wear clean, nonsterile, long-sleeved gowns.
- Wear single-use gloves.
- Use either single-use disposable equipment or dedicated equipment (e.g. stethoscopes, blood pressure cuffs, thermometers). If equipment needs to be shared between patients, clean and disinfect between each patient use (e.g. with ethyl alcohol 70%).
- Refrain from touching the eyes, nose or mouth with potentially contaminated hands.
- Avoid the movement and transport of patients out of the room or area unless medically necessary.
- Use designated portable X-ray equipment and other important diagnostic equipment. If transport is required, use predetermined transport routes and apply a medical mask to the patient to minimize exposure to staff, other patients and visitors.
- If transport is deemed necessary, notify the receiving area of necessary precautions as soon as possible before the patient's arrival.
- Ensure health-care workers who are transporting patients wear appropriate PPE and perform hand hygiene.
- Routinely clean and disinfect patient-contact surfaces.
- Limit the number of health-care workers, family members and visitors in contact with suspected or confirmed COVID-19 patients.
- Maintain a record of all people entering the patient's room, including all staff and visitors, and the purpose of their visits (4).

Airborne precautions for aerosol-generating procedures for people with suspected novel coronavirus infection

Some aerosol-generating procedures, such as tracheal intubation, non-invasive ventilation, tracheotomy, cardiopulmonary resuscitation, manual ventilation before intubation and bronchoscopy, have been associated with increased risk of transmission of coronaviruses (SARS-CoV, MERS-CoV). Ensure health-care workers who are performing aerosol-generating procedures take the following precautions (4):

- Use a particulate respirator at least as protective as a National Institute for Occupational Safety and Health (NIOSH)-certified N95, EU FFP2 or equivalent. When putting on a disposable particulate respirator, always perform a seal-check (see Annex 1) (9). Note that facial hair such as a beard can prevent a proper respirator fit.
- Use eye protection (goggles, face shield).
- Wear a clean, nonsterile, long-sleeved gown and gloves.
- If gowns are not fluid-resistant, use waterproof aprons for procedures with expected high fluid volumes that might penetrate the gown.

- Perform procedures in an adequately ventilated room: use natural ventilation with airflow of at least 160 litres per second per person; or ensure a negative-pressure room has at least 12 air changes per hour and controlled direction of airflow when using mechanical ventilation.
- Limit the number of people in the room to the absolute minimum required for the patient's care and support.

A mechanically ventilated room is equivalent to the airborne infection isolation room described by the United States Centers for Disease Control and Prevention (CDC), which should have special features in air handling and airflow direction, including (10):

- a negative-pressure differential greater than 2.5 Pa (0.01 inch water gauge), or an airflow differential greater than 56 l/s (125 cfm) exhaust versus supply;
- clean-to-dirty airflow;
- sealing of the room, allowing approximately 0.046 m² (0.5 square feet) leakage;
- more than 12 air changes per hour for a new building, or more than 6 air changes per hour for an existing building (equivalent to 40 l/s for a room measuring 4 × 2 × 3 m for an old building);
- an exhaust to the outside, or a high-efficiency particulate air (HEPA) filter if room air is recirculated.

Natural ventilation can be used in airborne precaution rooms (11). The purpose of this document is to provide basic design guidance for the use of natural ventilation for infection control.

Modes of transmission definitions

Table 1. Scope and definition of modes of transmission

Mode of transmission	Definition	Examples of the agents
Airborne	<p>Transmission of disease caused by dissemination of droplet nuclei that remain infectious when suspended in air over long distance (>1 m) and time. Airborne transmission can be further categorized into obligate or preferential airborne transmission.</p> <p>Obligate airborne transmission refers to pathogens that are transmitted only by deposition of droplet nuclei under natural conditions.</p> <p>Preferential airborne transmission refers to pathogens that can initiate infection by multiple routes, but are predominantly transmitted by droplet nuclei.</p>	Pulmonary tuberculosis, measles, chickenpox
Opportunistic airborne	Transmission of droplet nuclei at short range during special circumstances, such as the performance of aerosol-generating procedures associated with pathogen transmission.	SARS-Coronavirus, influenza
Droplet	Droplets are generated from an infected (source) person primarily during coughing, sneezing and talking. Transmission occurs when these droplets, containing microorganisms, are propelled a short distance (usually <1 m).	Adenovirus, respiratory syncytial virus, influenza, SARS-Coronavirus

SARS, severe acute respiratory syndrome.

Source: Atkinson J, Chartier Y, Pessoa-Silva CL, Jensen P, Li Y. Natural ventilation for infection control in health-care settings. Geneva: World Health Organization; 2009.

Managing the epidemic

Epidemic phases and stages of intervention

Because new infectious disease threats usually start locally, it is important to understand their dynamics in order to deny them the opportunity to spread further among people and overwhelm health systems. The dynamics of epidemic and pandemic diseases typically occur in four phases, although not all epidemic diseases necessarily go through each phase.

The first phase is introduction into a community. The second phase is an outbreak with localized transmission, where sporadic infections with the pathogen occur. In the third phase, the outbreak amplifies into an epidemic or pandemic, when the pathogen can transmit from human to human and causes a sustained outbreak in the community, threatening to spread beyond it. The fourth phase is reduced transmission, when human-to-human transmission of the pathogen decreases, owing to acquired population immunity or effective interventions to control the disease (Figure 1) (12).

The dynamics of epidemics, as described above, define the response and the sequence of interventions that then become necessary. Here there are four crucial stages. First is the anticipation of new and re-emerging diseases to facilitate faster detection and response. Second is the early detection of emergence in animal and human populations. Third is the containment of the disease at the early stages of transmission. Fourth is the control and mitigation of the epidemic during its amplification (12).

Figure 1. Epidemic phases and response interventions

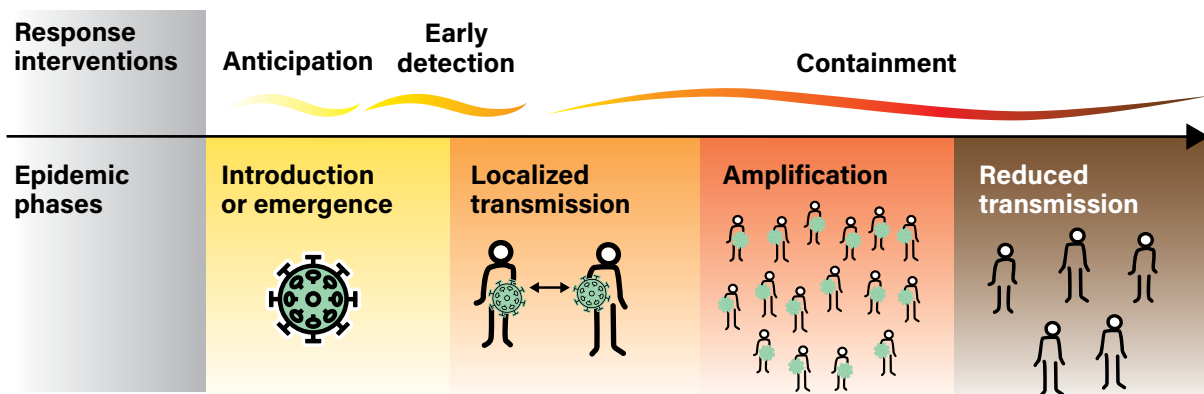

Source: Managing epidemics: key facts about major deadly diseases. Geneva: World Health Organization; 2018.

The following sections propose different ways to manage the outbreak according to the specific phase. This document does not pretend to be an exhaustive description but rather a series of recommendations to be considered and adapted to the specific context.

Anticipation

In this first stage of response, introduction of the disease cannot be predicted, but it can certainly be anticipated. The anticipation of risk enables a focus on the most likely threats. Anticipation encompasses forecasting the most likely introduction point through risk analysis, and the quick identification of the drivers that will worsen the impact or facilitate the spread. Preparedness plans, based on lessons learned from past experiences, should contain a variety of scenarios to allow for a reactive response to the first imported cases.

Early detection

Early detection allows the rapid implementation of containment measures, which are the key to reducing the risk of amplification and potential international spread. Early detection begins at the health-care setting, and health-care workers must be trained to recognize potential suspected cases. The role of health-care workers is also to reduce the risk of community transmission by isolating severely ill people; to prevent household transmission by protecting caregivers at home; and to reduce the mortality rate. Health-care workers must also know how to protect themselves, use IPC measures, and avoid outbreaks amplified in health-care facilities. In order to do so, the emergency referral system (control and command centre) should be put into place to move people suspected to be infected to the appropriate site or centre for diagnosis and treatment.

Containment

Effective and rapid containment of the disease is as vital as early detection in order to avoid a large-scale epidemic. Rapid containment should start as soon as the first case is detected. It requires skilled professionals to safely implement the necessary countermeasures. Pretraining of these professionals is essential to guarantee the safety and efficiency of operations.

For the anticipation, early detection and containment response, from the introduction to the localized transmission phase, the following are recommended:

- Foresee a proper triage system at all different levels of the public health system to enable early detection of potential suspected cases. It should include temporary isolation capacity, trained staff, protocols and all needed supplies.
- Designate health facilities able to provide the adequate level of care, which most probably will be hospitals with available intensive care units, and set up correct IPC and engineering measures.
- Define a clear referral pathway for suspected and confirmed cases with dedicated ambulance service to facilitate referrals from primary health centres to identified treatment facilities.
- Develop a control and mitigation plan

Scenarios of transmission

Countries or subnational areas will have to respond rapidly to one or more epidemiological scenarios. Currently, four transmission scenarios are observed:

1. Countries with no cases (no cases).
2. Countries with one or more cases, imported or locally acquired (sporadic cases).
3. Countries experiencing case clusters in time, geographic locations, or by common exposure (clusters of cases).
4. Countries experiencing larger outbreaks of local transmission (community transmission).

Figure 2. Severity of disease and corresponding resource requirements

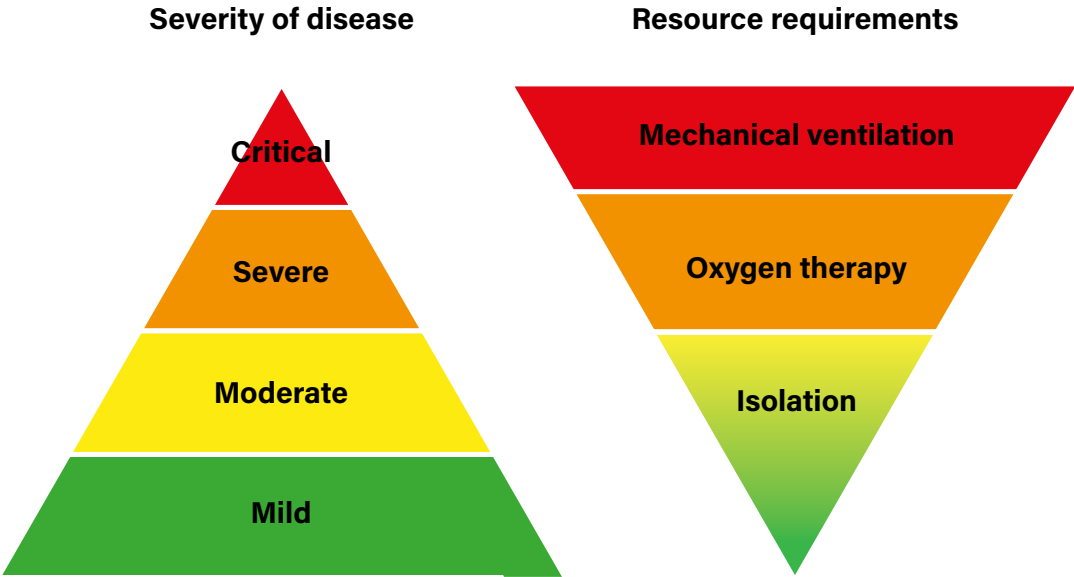

Scenario and strategic priorities

Countries will experience one or more of these situations at the subnational level and must tailor their approach to the local context. For clinical care, six major interventions must be put into place immediately, and then scaled up according to epidemiologic scenarios (see Table 2).

Based on the largest patient cohort to date, about 40% of patients with COVID-19 may have mild disease, where treatment is mostly symptomatic and does not require inpatient care; about 40% of patients have moderate disease that may require inpatient care; 15% of patients will have severe disease that requires oxygen therapy or other inpatient interventions; and about 5% have critical disease that requires mechanical ventilation.

However, the evolution of the outbreak in some countries has shown a higher proportion of severe and critical cases and the need to rapidly increase surge capacity to prevent rapid exhaustion of biomedical supplies and staff. In some countries, case doubling rates every three days have been observed.

Table 2. Key recommendations based on case severity and risk factors, irrespective of transmission scenario

Case severity, risk factors	Recommendations
Mild	Patients should be instructed to self-isolate and contact COVID-19 information line for advice on testing and referral.
Moderate, with no risk factors	Test suspected COVID-19 cases according to diagnostic strategy. Isolation/ cohorting in: <ul style="list-style-type: none"> • Health facilities, if resources allow. • Community facilities (e.g. stadiums, gymnasiums, hotels) with access to rapid health advice (i.e. adjacent COVID-19 designated health post/EMT-type 1, telemedicine). Self-isolation at home according to WHO guidance.
Moderate, with risk factors	Patients should be instructed to self-isolate and call COVID-19 hotline for emergency referral as soon as possible.
Severe	Hospitalization for isolation (or cohorting) and inpatient treatment.
Critical	Test suspect COVID-19 cases according to diagnostic strategy.

Table 3. Summary of strategic priorities by scenario

Scenario	Priorities
No cases	<ol style="list-style-type: none"> 1. Set up screening and triage protocols at all points of access to the health system, including primary health centres, clinics, hospital emergency units, and ad hoc community settings. 2. Set up COVID-19 telephone hotline and referral system to refer patients to the appropriate destination for clinical assessment and/or testing as per local protocol. 3. Set up COVID-19 designated wards in health facilities. 4. Conduct active case finding, contact tracing and monitoring, quarantine of contacts, and isolation of suspected cases. 5. Prepare for next scenario.
Sporadic cases	<ol style="list-style-type: none"> 1. Screen and triage at all points of access to the health system, including primary health centres, clinics, hospital emergency units, and ad hoc community settings. 2. Care for all suspected and confirmed COVID-19 patients in isolation (or cohorting) according to disease severity and acute care needs for treatment at the COVID-19 designated treatment area (Table 2). 3. Continue rapid and thorough contact tracing and quarantine of contacts. 4. Prepare for next scenario.
Clusters of cases	<ol style="list-style-type: none"> 1. Screen and triage at all points of access to the health system, including primary health centres, clinics, hospital emergency units, and ad hoc community settings. 2. Care for all COVID-19 patients in the designated treatment area, according to disease severity and acute care needs according to the recommendations in Table 9. 3. Surge by repurposing wards or ICUs into COVID-19 wards and hospitals. 4. Where health facilities can no longer manage patients with mild or moderate disease, isolate patients who are not at high risk for severe disease (< 60 years of age, no co-morbid diseases) either in community facilities (e.g. stadium, gymnasium, hotel, or tent) with access to rapid health advice (i.e. via adjacent dedicated COVID-19 health post, telemedicine) or at home according to WHO guidance. If patients develop symptoms that may correspond to complications, ensure rapid referral to hospital. 5. Plan for new structures to augment the health system based on the assumption that the number of cases will double every 3 to 7 days subject to the effectiveness of public health interventions.
Community transmission	<ol style="list-style-type: none"> 1. Screen and triage at all points of access to the health system, including primary health centres, clinics, hospital emergency units, and ad hoc community settings. 2. Care for all suspected and confirmed COVID-19 patients in the designated treatment area, according to disease severity and acute care needs according to the recommendations in Table 2. 3. Surge the health system with new structures established for care delivery, including rapid extension of designated hospitals to care for COVID-19 patients. 4. New hospitals or temporary structures can serve to augment COVID-19 patient care or essential health services, depending on national strategy. 5. Referrals adopt a 'hub and spoke' model, with a central COVID-19 referral facility and all other health facilities in each geographical area referring patients to the nearest centre (see referral pathway b). 6. Manage all mild and low- to moderate-risk patients with confirmed disease in designated community facilities (e.g. stadium, gymnasium, hotel or tent) with access to rapid health advice (i.e. via adjacent dedicated COVID-19 health post, telemedicine) or at home according to WHO guidance and national or subnational capacity. If patients develop symptoms that may correspond to severe disease or complications, ensure rapid referral to hospital. 7. Depending on testing strategy and capacity, mild and moderate patients may not be tested, and advised to self-isolate either in cohorted community facilities or at home.

Key clinical and IPC activities for different transmission scenarios

Activities for preparing and responding to different transmission scenarios should be part of an overall strategy, and each part of the health sector response tailored accordingly including facilities, staff, supplies and standards of care.

Table 4. Key clinical and IPC activities for different transmission scenarios

	No case	Sporadic cases	Clusters of cases	Community transmission
Facility space, including for triage	Usual space. Enhanced screening and triage at all points of first access to the health system.	Dedicated COVID-19 patient care areas within health facility (e.g. infectious disease ward, isolation rooms in emergency or ICU wards).	More patient care areas repurposed for COVID-19 within the health system, especially for severe cases.	Expanded care for severe cases in new hospitals or temporary hospital facilities.
Staff	Usual staff. Train all staff for safe COVID-19 recognition and care. Activate IPC task force.	Additional staff called in and trained.	Staff extension (supervision of larger number of staff). Expanded care team model with task shifting or task sharing, and relevant changes in responsibility.	Make every effort to ensure sufficient staff available. Expanded care team model and additional emergency medical teams (EMTs).
Supplies	On-hand supplies. Equip wards for COVID-19 treatment. Identify essential equipment and supplies, including oxygen. Prepare expanded local supply chain.	Expanded inventory of supplies with detailed protocols for use. Activate expanded local supply chain. Prepare national supply chain.	Conservation, adaptation, selected re-use when safe. Activate contingency planning and procurement for essential equipment and supplies. National supply chain. Prepare expanded supply chain at global level.	Activate contingency planning should critical equipment be in short supply. Determine allocation of life-saving resources for health-care workers and patients. Activate expanded global supply chain.
Standard of care	Usual care with enhanced awareness and recognition of immediate needs for first COVID-19 patients.	Usual care and treatment for all patients, including those with COVID-19.	Identify context-relevant core services. Shift service delivery platforms. Consider reduction in elective patient encounters, including elective surgical procedures.	Mass critical care (e.g. open ICU for cohorted patients).
Care areas expansion	No requirements for expansion.	Designate 10 beds per suspected COVID-19 case.	Expand COVID-19 patient-care areas by a factor of 3 to 5.	Expand COVID-19 patient care areas by a factor of 5 to 8.

During the first three phases, the patient's journey could be represented as in Figure 3, where a primary health centre at the triage level identifies people suspected of having the infection, who subsequently are referred to the hospital level for testing or treatment.

Figure 3. First phases of a patient's journey

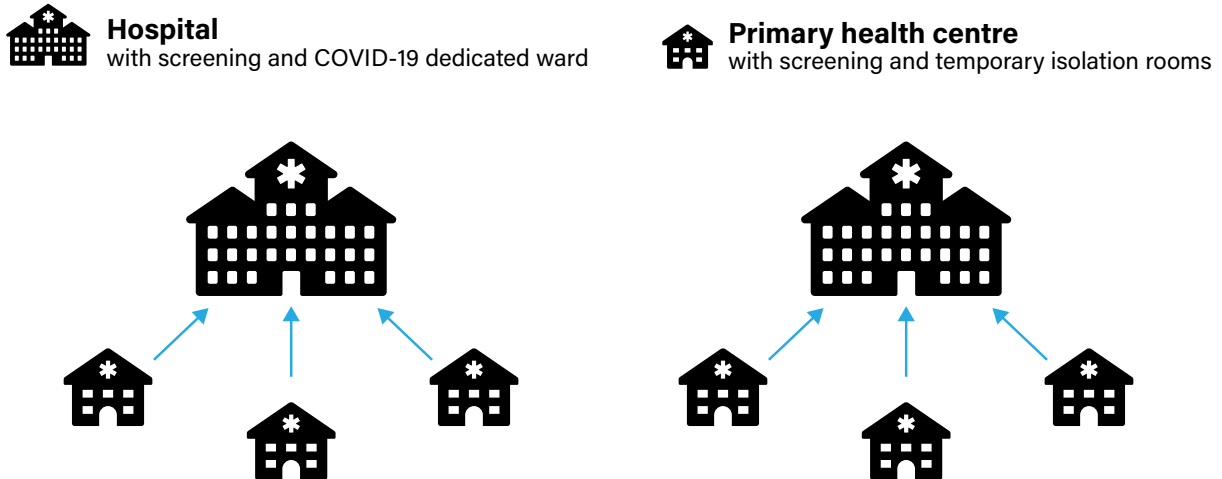

Once the infectious disease reaches an epidemic or pandemic level with transmission at the community level, the goal of the response is to mitigate its impact and reduce its incidence, morbidity, mortality and disruption.

During this phase it is necessary to protect the public health system from being overwhelmed and to centralize specific case management in order to simplify the referral pathway and reduce the risk of exposure for health-care workers, patients and communities. This does not mean that new facilities have to be built, as existing buildings can be reconverted into SARI treatment centres.

The patient's journey in this phase is represented in Figure 4.

Figure 4. Patient's journey during the control and mitigation phases

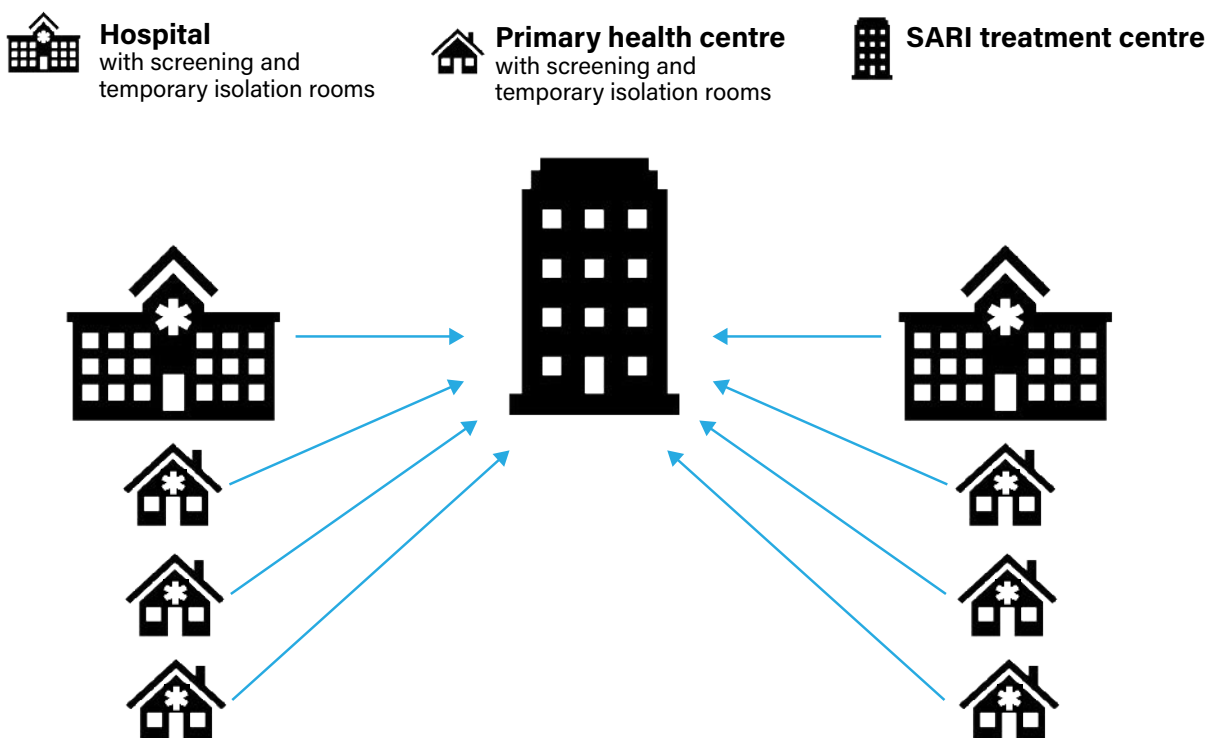

Ventilation

Ventilation moves outdoor air into a building or a room, and distributes the air within the building or room. The general purpose of ventilation in buildings is to provide healthy air for breathing by diluting the pollutants originating in the building and removing the pollutants from it (13).

Building ventilation has three basic elements (8):

- Ventilation rate: the amount and quality of outdoor air provided into the space.
- Airflow direction: the overall airflow direction in a building, which should be from clean to dirty zones.
- Air distribution or airflow pattern: the external air should be delivered to each part of the space in an efficient manner, and the airborne pollutants generated in each part of the space should be removed in an efficient manner.

There are three methods that may be used to ventilate a building: natural, mechanical and hybrid (mixed-mode) ventilation (8).

Natural ventilation

Natural forces (e.g. winds and thermal buoyancy force due to indoor and outdoor air density differences) drive outdoor air through purpose-built building envelope openings, such as windows, doors, solar chimneys, wind towers and trickle ventilators. This natural ventilation of buildings depends on climate, building design and human behaviour (8).

When wind strikes a building, it induces a positive pressure on the windward face and negative pressure on the leeward face. This drives the air to flow through windward openings into the building to the low-pressure openings at the leeward face (Figure 5). It is possible to estimate the wind pressures for simple buildings.

Figure 5. Wind-induced flow directions in a building

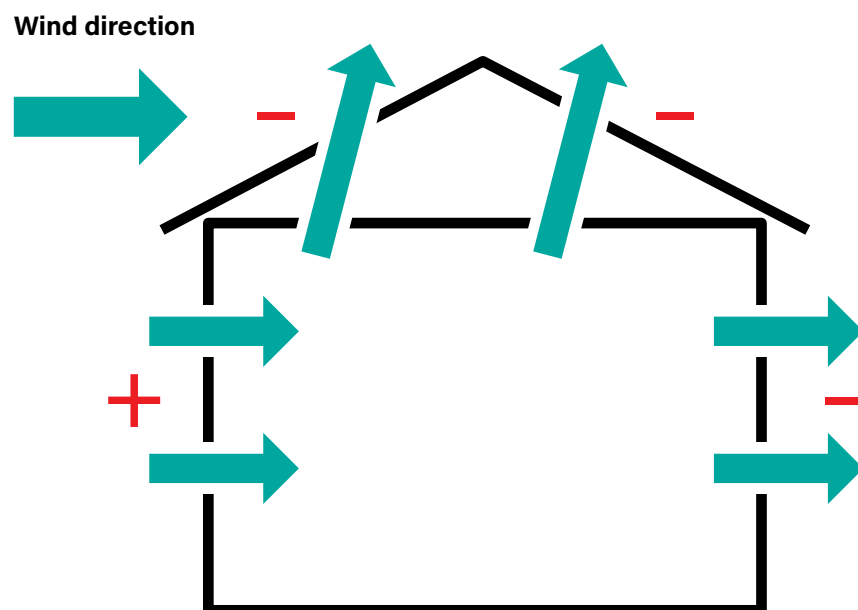

Source: Atkinson J, Chartier Y, Pessoa-Silva CL, Jensen P, Li Y. Natural ventilation for infection control in health-care settings. Geneva: World Health Organization; 2009.

For single-sided ventilation with the rooms otherwise hermetically sealed, there is contribution only from the fluctuating components, and not from mean wind pressures (Figure 6). This is a common design; over time, however, there becomes significant leakage around doors and other room penetrations. It must be remembered that sufficient air changes per hour are not necessarily achieved just because a window is open (8).

Figure 6. Fluctuating components contributing to single-sided airflow

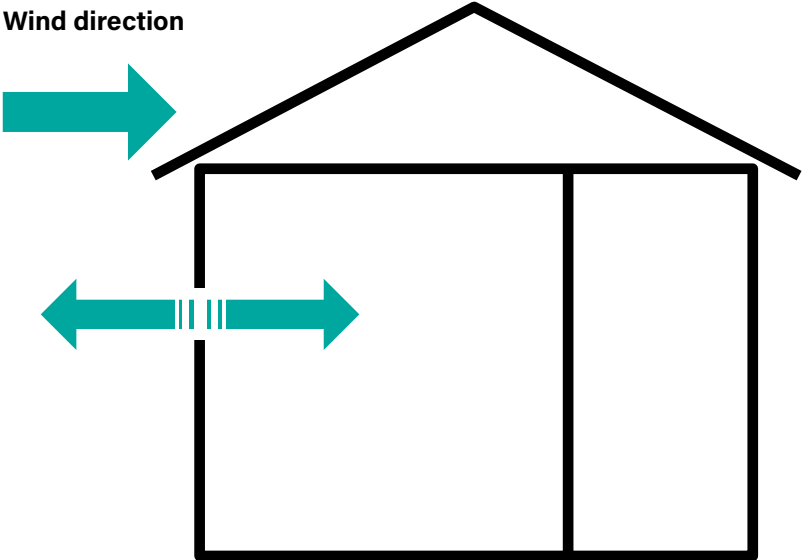

Source: Atkinson J, Chartier Y, Pessoa-Silva CL, Jensen P, Li Y. Natural ventilation for infection control in health-care settings. Geneva: World Health Organization; 2009.

As a rule of thumb, the wind-driven natural ventilation rate through a room with two opposite openings (e.g. a window and a door) can be calculated as follows (8):

$$ACH = \frac{0.65 \times \text{wind speed (m/s)} \times \text{smallest opening area (m}^2\text{)} \times 3600 \text{ (s/h)}}{\text{room volume (m}^3\text{)}}$$

or calculated as ventilation rate:

$$\text{Ventilation rate (l/s)} = 0.65 \times \text{wind speed (m/s)} \times \text{smallest opening area (m}^2\text{)} \times 1000 \text{ l/m}^3$$

Table 5 provides estimates of the air changes per hour and ventilation rate due to wind alone at a wind speed of 1 m/s, assuming a ward of length 7 m, width 6 m and height 3 m, with a window measuring 1.5 × 2 m and a door measuring 1 m × 2 m (smallest opening) (8).

Table 5. Estimated air changes per hour and ventilation rate for a ward measuring 7 × 6 × 3 m

Openings	ACH	Ventilation rate (l/s)
Open window (100%) + open door	37.0	1300
Open window (50%) + open door	28.0	975
Open window (100%) + closed door	4.2	150

Source: Atkinson J, Chartier Y, Pessoa-Silva CL, Jensen P, Li Y. Natural ventilation for infection control in health-care settings. Geneva: World Health Organization; 2009.

The wind speed refers to the value at the building height at a site sufficiently away from the building without any obstructions (e.g. at an airport).

For general ward rooms with natural ventilation, adequate ventilation is considered to be 60 litres per second per patient (4).

Mechanical ventilation

Mechanical fans drive mechanical ventilation. Fans can either be installed directly in windows or walls, or be installed in air ducts for supplying air into or exhausting air from a room. The type of mechanical ventilation used depends on the climate. For example, in warm and humid climates, infiltration may need to be minimized or prevented to reduce interstitial condensation (which occurs when warm, moist air from inside a building penetrates a wall, roof or floor and meets a cold surface). In these cases, a positive-pressure mechanical ventilation system is often used. Conversely, in cold climates, exfiltration needs to be prevented to reduce interstitial condensation, and negative-pressure ventilation is used. For rooms with locally generated pollutants, such as bathrooms, toilets and kitchens, a negative-pressure system is often used (8).

Hybrid or mixed-mode ventilation

Hybrid or mixed-mode ventilation relies on natural driving forces to provide the desired (design) flow rate, and uses mechanical ventilation when the natural ventilation flow rate is too low.

When natural ventilation alone is not suitable, exhaust fans (with adequate pretesting and planning) can be installed to increase ventilation rates in rooms housing patients with airborne infections. This simple type of hybrid ventilation needs to be used with care, however. The fans should be installed where room air can be exhausted directly to the outdoor environment through a wall or the roof. The size and number of exhaust fans depends on the targeted ventilation rate and must be measured and tested before use. Problems associated with the use of exhaust fans include installation difficulties (especially for large fans), noise (particularly from high-power fans), increased or decreased temperature in the room, and the requirement for a nonstop electricity supply. If the environment in the room causes thermal discomfort, spot cooling or heating systems and ceiling fans may be added.

Another possibility is the installation of whirlybirds (whirligigs, wind turbines) (Figure 7) that do not require electricity and provide a roof-exhaust system increasing airflow in a building.

Figure 7. Whirlybird



Source: <https://www.askthebuilder.com/roof-turbine-vents/>.

Advantages and disadvantages of different types of hospital ventilation system: summary

Table 6 summarizes the advantages and disadvantages of different types of ventilation system used in hospitals.

Table 6. Advantages and disadvantages of different types of ventilation system used in hospitals

	Mechanical ventilation	Natural ventilation	Hybrid (mixed-mode) ventilation
Advantages	Suitable for all climates and weather with air-conditioning as climate dictates More controlled and comfortable environment Smaller range of control of environment by occupants	Suitable for warm and temperate climates — moderately useful with natural ventilation possible 50% of the time Lower capital, operational and maintenance costs for simple natural ventilation Capable of achieving high ventilation rate Large range of control of environment by occupants	Suitable for most climates and weather Energy-saving More flexible
Disadvantages	Expensive to install and maintain Reported failure rate in delivering the required outdoor ventilation rate Potential for noise from equipment	Easily affected by outdoor climate and/or occupant's behaviour More difficult to predict, analyse and design Reduces comfort level of occupants when hot, humid or cold Inability to establish negative pressure in isolation areas, but may be provided by proper design; depends on situation Potential for noise intrusion High-tech natural ventilation shares some of the limitations and disadvantages of mechanical ventilation	May be expensive May be more difficult to design

Source: Atkinson J, Chartier Y, Pessoa-Silva CL, Jensen P, Li Y. Natural ventilation for infection control in health-care settings. Geneva: World Health Organization; 2009.

Proposed hybrid ventilation system for severe and critical wards

To provide the best control to counteract the risks, the decision of whether to use mechanical or natural ventilation for infection control should be based on need, availability of resources, and the cost of the system. Considering the need to have a functioning SARI treatment centre within a short time, the difficulty of securing sealed chambers for negative pressure (except in concrete buildings), and the importance of meeting IPC requirements, this document advises installing a hybrid ventilation system for wards for patients with severe disease and intensive care units, as this is easier to install than a mechanical system and more flexible in terms of ventilation rate.

As described above, hybrid (mixed-mode) ventilation relies on natural driving forces to provide the desired flow rate and uses mechanical ventilation when the flow rate is lower than that required to produce natural ventilation. Local environmental conditions vary from setting to setting, and so a top-down hybrid ventilation system is proposed.

With top-down ventilation (fan-assisted stack plus a wind tower), when there is insufficient solar radiant loading on the stack (evenings and inclement days), the exhaust ventilation rate is supplemented by extraction fans while the supply ventilation rate is supplemented by the wind tower (wind scoop) (Figure 8).

The air extractor will easily permit control of the ventilation rate, meet the standard of air changes per hour required, and ensure a constant unidirectional top-down airflow.

Figure 8. Top-down hybrid ventilation

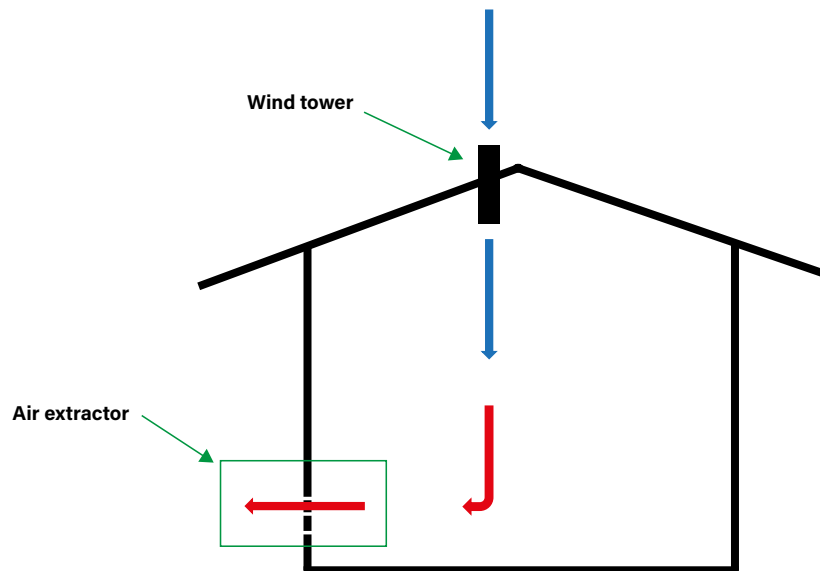

Extraction fan technical requirements

There are many extraction fans available, such as bathroom and kitchen extractor fans, silent extractor fans, wall fans, and axial fans to remove fumes, smoke, heat and steam (Figure 9). In order to follow the IPC standards required for the SARI treatment centre, the following specifications should be met:

- Wall-mounted only: the airflow should be top-down, from the ceiling to the floor. For this reason, the extractor must be installed on the wall about 20 cm above ground level in order to avoid damage due to splashes while cleaning and disinfecting the floor.
- Backdraught shutter: to direct the exhaust airflow.
- Power rating: according to availability and the country's regulations.
- Sound: 38 dBA at 3 m (or as quiet as possible) to avoid constant noise that may disturb patients and staff.
- Airflow (measured in cubic metres per hour or litres per second): according to the room's maximum bed capacity, considering at least the minimum standard of 160 litres per second per patient or 576 cubic metres per hour per patient.

The formula to calculate the extraction fan airflow needed given a specific bed capacity is:

$$\text{Extractor airflow [l/s]} = \text{maximum bed capacity} \times 160 \text{ l/s/patient}$$

or

$$\text{Extractor airflow [m}^3\text{/h]} = \text{maximum bed capacity} \times 576 \text{ m}^3\text{/h/patient}$$

For example, to calculate the extractor airflow needed for a five-bed room:

$$\text{Extractor airflow [l/s]} = \text{Maximum bed capacity} \times 160 \text{ l/s/patient}$$

$$\text{Extractor airflow [l/s]} = \text{five-bed capacity} \times 160 \text{ l/s/patient}$$

$$\text{Extractor airflow [l/s]} = 800 \text{ l/s}$$

Figure 9. Air extractor models



Source: <https://www.pinterest.it/>.

Installing an air extractor in a patient's room

The air extractor should be installed properly to create the correct airflow (Figure 10). Air should always move from clean to more dirty zones, and in a top-down direction, in order to reduce nosocomial infections. It is advisable to install the air extractor at least 20 cm above the floor to avoid possible splashing and damage while cleaning the room.

Figure 10. Installing an air extractor in a patient's room

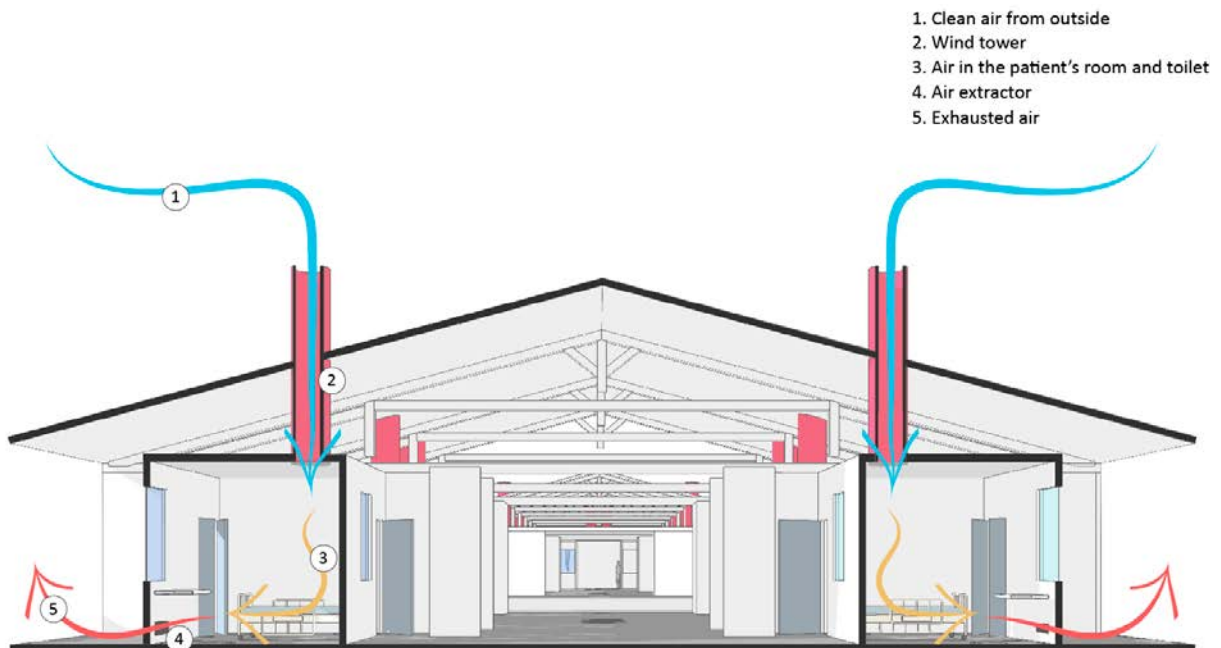

Exhausted air

Air from the room can be exhausted directly to the outdoors, where the droplet nuclei will be diluted in the outdoor air, or passed through a special HEPA filter that removes most (99.97%) of the droplet nuclei before it is returned to the general circulation. If a HEPA filter is not used, the air should be exhausted directly to the outside away from air-intake vents, people and animals (14).

Air dilution should always be the favoured solution. If not possible, however, three different treatments for exhausted air are proposed here.

HEPA filter

HEPA is a pleated mechanical air filter that theoretically removes at least 99.97% of dust, pollen, mould, bacteria and airborne particles with a size of 0.3 microns (μm). The diameter specification of 0.3 microns responds to the worst case of the most penetrating particle size. Particles that are larger or smaller are trapped with higher efficiency. Using the worst-case particle size results in the worst-case efficiency rating (i.e. 99.97% or better for all particle sizes). All air cleaners require periodic cleaning and filter replacement to function properly; follow the manufacturer's recommendations on maintenance and replacement.

The minimum efficiency reporting value (MERV) is the ability of a filter to capture larger particles with a size between 0.3 and 10 microns (μm): the higher the rating, the better the filter is at trapping specific types of particles. This value is helpful in comparing the performance of different filters. The rating is derived from a test method developed by the American Society of Heating, Refrigerating, and Air Conditioning Engineers (www.ashrae.org).

Installing a HEPA filter after the air extractor could be a solution for exhausted air treatment (Figure 11), but availability and maintenance may be a problem.

Figure 11. HEPA filter installation

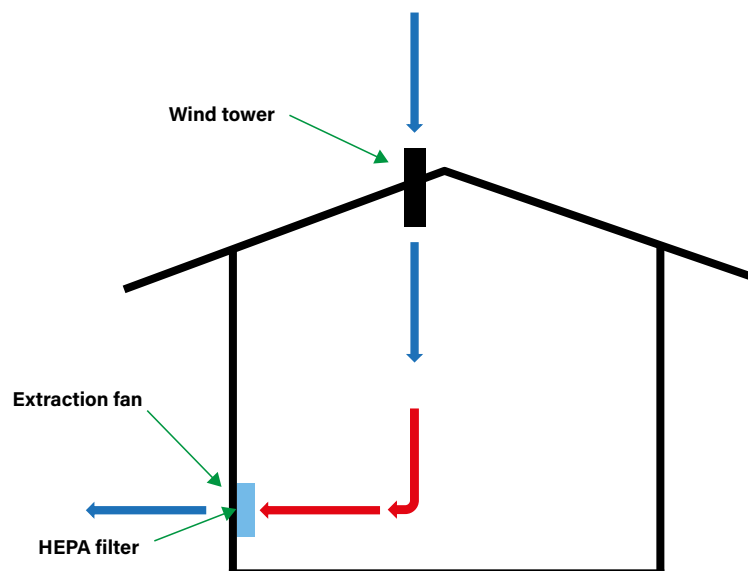

Portable air filtration systems

To simplify the installation, reduce the construction time and ensure proper air treatment, facilities may benefit from the use of a portable HEPA filter unit equipped with the proper fittings and ducting to exhaust air from a room to create the required ventilation flow rate and exhausted air treatment (15).

Placement of the unit in any area (e.g. sampling room, waiting room, ward) must be done with consideration of the following (15):

- The unit must not create an obstruction that would interfere with the proper delivery of health care.
- The unit should be placed as close to the expected source of the contamination as possible to increase effective capture of the infectious or hazardous agents. Capture ability decreases with the square of the distance from the intake, and so the distance from the patient has an impact on the ability to filter out droplet nuclei.
- The air flowing out of the unit must not be directed in a way that would cause discomfort to patients, visitors or staff.
- If the portable air filtration unit has adjustable airflow, then the airflow that is appropriate to the size of the room to give the desired air changes per hour should be selected. Unless other considerations (e.g. noise, discomfort of blowing air) prevail, the unit should normally be run at the highest fan setting since this will provide the maximum filtration and air changes per hour. In smaller rooms, the recommended minimum 12 air changes per hour may be achieved at a lower fan setting. Under these conditions, users may opt to lower the fan settings.
- Keep all doors to the room closed as much as possible (16).
- Place the portable HEPA unit at the maximum distance across the room from the door.
- Make sure the operating panel faces the room and is unobstructed.
- Run the portable HEPA unit for at least 30 minutes after the patient leaves the room if the patient is on an aerosol-generating procedure when they leave. During this time, respiratory protection should be worn by staff entering room. New patients should not be placed in the room (16).

Portable air filtration units require proper preventive maintenance for their effective continued operation:

- The procedure should specify recommended PPE when performing maintenance on the unit.
- The maintenance procedure should be performed in an area safely away from any patients' locations. It is recommended that maintenance is done in a location with appropriate ventilation, including negative pressure, designated for such activities. The area should be contained and easily cleaned or decontaminated.
- Based on the manufacturer's recommendations and any additional suggested protocol from facility maintenance, a standard routine maintenance procedure should be developed for the unit. This maintenance should include (but not be limited to):
 - changing of pre-filters (on a schedule or as needed per magnehelic gauge); be sure to include details on "bag out" protocol and proper disposal of filters; since these filters might be contaminated, they should be treated as medical waste and handled with appropriate PPE;
 - operational check for proper operation;
 - interior cleaning of unit if needed (without disturbing seal on HEPA filter);
 - changing of ultraviolet (UV) lamp according to the manufacturer's recommendations (based on hours of use);
 - general safety check (electrical, mechanical);
 - lubrication where needed (fans and so on should have sealed bearings and should not require lubrication).
- The HEPA unit must be leak tested and certified. This should be done initially and every time the HEPA filter is changed. The frequency of changing the HEPA filter should be based on the manufacturer's recommendations (e.g. annually or when indicated by the manometer (differential pressure gauge) across the HEPA filter.

- The portable filtration unit should be monitored regularly (e.g. every week) for leaks. This can be done simply by having designated staff monitor the pressure drop across the filter by checking the gauge.

The portable air filtration system could be used as a mechanical fan with integrated HEPA filter to exhaust potential contaminated air directly outside (Figure 12).

Figure 12. Portable air filtration system with air exhaustion

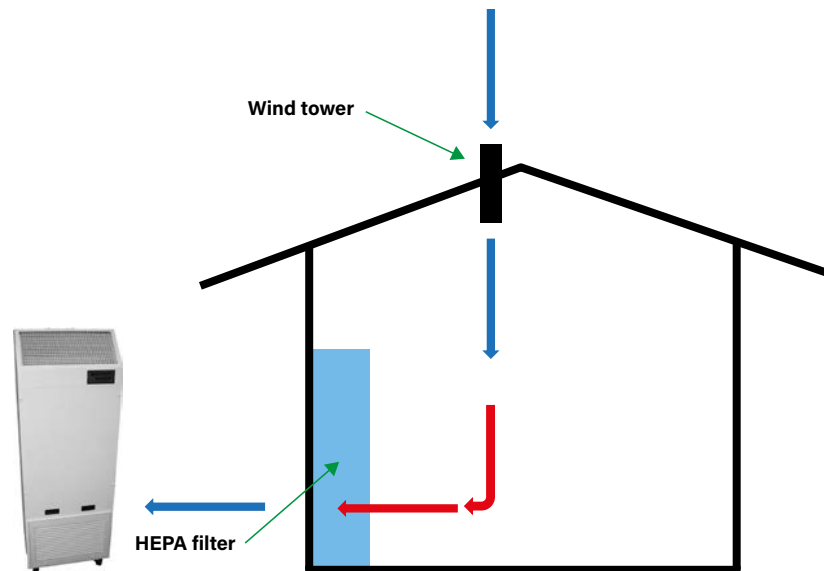

CDC. Center for Disease Control and Prevention. Chapter 7 - Tuberculosis Infection Control. (2017).

Alternatively, it could be used to ensure required air changes per hour and air recirculation in a closed environment (Figure 13).

Figure 13. Portable air filtration system with air recirculation

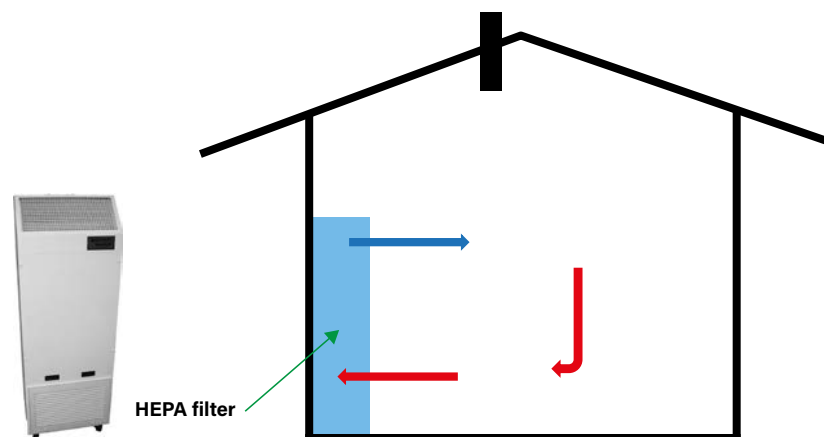

CDC. Center for Disease Control and Prevention. Chapter 7 - Tuberculosis Infection Control. (2017).

Ultraviolet germicidal irradiation

Because the clinical effectiveness of UV systems may vary, ultraviolet germicidal irradiation (UVGI) is not recommended for air management before air recirculation from airborne isolation rooms. It is not

recommended as a substitute for HEPA filtration, local exhaust of air to the outside, or negative pressure (17), but it can be used as a complementary system (Figure 14).

UVGI is electromagnetic radiation that can destroy the ability of microorganisms to reproduce by causing photochemical changes in nucleic acids. Wavelengths in the UVC range are especially damaging to cells because they are absorbed by nucleic acids. The spectrum of UV light includes wavelengths of about 100–400 nm (18). The subdivisions of most interest include UVC (200–280 nm) and UVB (280–320 nm). Microbes are uniquely vulnerable to light at wavelengths at or near 253.7 nm because the maximum absorption wavelength of a DNA molecule is 260 nm (19). Additionally, efficacy of far-UVC light inactivation has been proven on airborne viruses carried by aerosols. For example, a very low dose of 2 mJ/cm² of 222-nm light inactivates more than 95% of airborne H1N1 virus (20), while virus-reduction factors of 3.4 or more for SARS-CoV have been achieved with the UVC-based system in platelet concentrates (21).

Effective room air disinfection depends on circulating maximal room air through the duct and the velocity at which it is circulated (22). For this reason, it is essential to define the size (volume) of the air duct (sealed space) according to the capacity of the air extractor. The higher the contact time, the more effective the disinfection.

Figure 14. Ultraviolet light duct

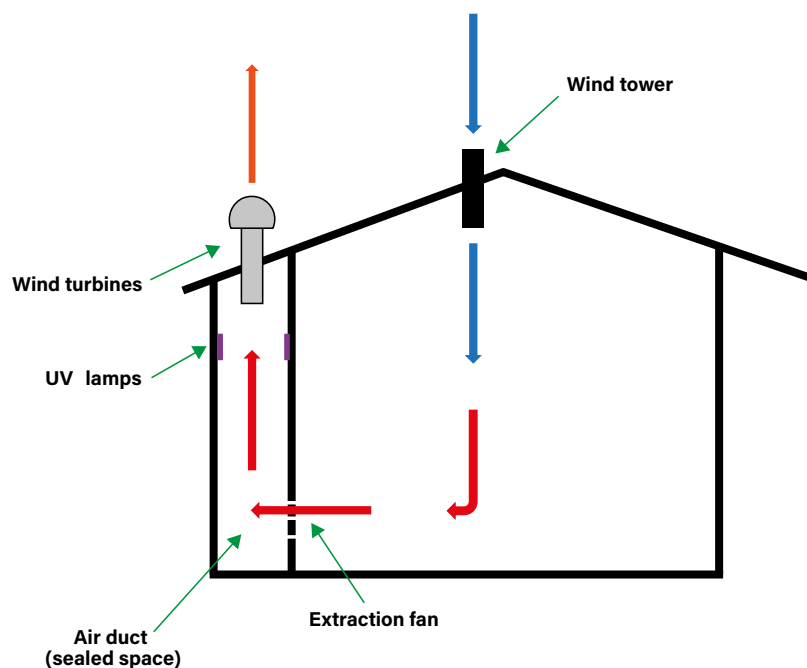

UVC lamp requirements

The most important requirement is the UV wavelength, as it directly affects the disinfection efficiency of the lamp. Only use a lamp providing a wavelength of 254 nm (0.254 μm). There are three available UV sources that provide the required wavelength of 254 nm (Table 7).

Electrical consumption should be taken into account, as this will drive the electrical supply choice. Another important aspect is the surface temperature. Bearing in mind the centre will be a temporary structure, lamps reaching high surface temperature may become a serious threat by increasing the likelihood of fire.

Table 7. Summary of technical specifications of different types of UV lamps

	Conventional low-pressure UV tube	Amalgam low pressure UV tube	Medium pressure UV lamps
UV emission spectrum	Narrow band	Narrow band	Broad band
UVC wavelength	254 nm	254 nm	200–280 nm
% of electrical input power converted in UVC light	40%	30%	15%
Surface temperature	40 degrees C	100 degrees C	600–900 degrees C
Influence on ambient temperature	Large	Lower	Negligible
Electrical input power range	5–50 W	50–300 W	1-30 kW

UV lamp installation

Always try to install the lamps in a way to avoid shaded areas and to ensure all the air volume is exposed to the light. Consider an electrical installation, as proposed below, as this reduces useless utilization of the UV light and ensures proper follow-up in the case of a burnt-out bulb (Figure 16).

UV light exposure risk

UV radiation is a known cause of skin cancer, skin ageing and eye damage, and it may affect the immune system. As UV radiation can neither be seen nor felt, it is important that workers who have the potential to be exposed to intense levels of UV radiation are aware of the risks and are regularly reminded to take prompt and appropriate protective action (23).

All UV light disinfection rooms should be properly labelled (Figure 16) and kept locked to avoid any risk of exposure for staff and patients.

Figure 15. UV lamp installation scheme

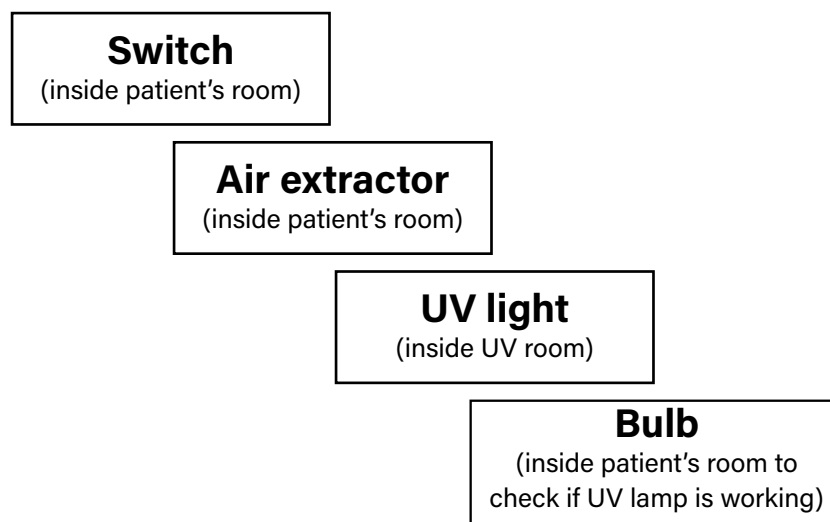

Figure 16. All ultraviolet light disinfection rooms should be properly labelled



Testing the ventilation/exhausted air systems

The purpose of testing the ventilation/exhausted air systems is:

- to verify the volumetric flow rate(s);
- to check the performance of the systems periodically;
- to obtain specific information and compare it with design data;
- to set a baseline for periodic maintenance checks;
- as a basis for design of future installations where satisfactory air-contaminant control is currently being achieved;
- to meet governmental or regulatory requirements for certain types of process.

The easiest and most convenient way to test airflow is to visualize it using safe smoke. Other, more sophisticated testing systems are also available (24).

Proposed ventilation system and exhausted air treatment by area or service: summary

Table 8 summarizes the available ventilation systems and exhausted air treatments by area or service. Note that dilution should be the favoured method for air management whenever possible.

Table 8. Summary of ventilation systems and exhausted air treatment by area or service



Area or service	Proposed ventilation system	Proposed exhausted air treatment
Staff area	Natural ventilation	Dilution ¹
Triage	Natural ventilation	Dilution
Waiting room	Natural ventilation	Dilution
Sampling room	Natural ventilation	Dilution
	Hybrid ventilation	HEPA filter
Short-stay ward (mild cases)	Natural ventilation	Dilution
Moderate cases ward	Natural ventilation	Dilution
	Hybrid ventilation	HEPA filter
Severe and critical ward	Hybrid ventilation	Dilution
	Mechanical ventilation	HEPA filter
Waste zone	Natural ventilation	Dilution
Morgue	Natural ventilation	Dilution

¹ For safe dilution, the air should be exhausted directly to the outside away from air-intake vents, people and animals.

Description of proposed exhausted air treatment system

Table 9 describes the proposed exhausted air treatment system.

Table 9. Proposed exhausted air treatment system

	HEPA filter	Portable HEPA filter	UVGI
Image			
Description	Pleated mechanical air filter that can theoretically remove at least 99.97% of dust, pollen, mould, bacteria and airborne particles with a size of 0.3 microns (μm)	A portable HEPA filter unit equipped with the proper fittings and ducting to exhaust air from a selected room to create the required ventilation flow rate and exhausted air treatment	Electromagnetic radiation that can destroy the ability of microorganisms to reproduce by causing photochemical changes in nucleic acids. Wavelengths in the UVC range are especially damaging to cells because they are absorbed by nucleic acids
Application	Air filtration in hospitals, isolation rooms and laboratory facilities	Ventilation and air filtration in hospitals, isolation rooms and laboratory facilities	Air-cleaning measure; UVGI is effective in reducing the transmission of airborne bacterial and viral infections in hospitals, military housing and classrooms
Air extractor needed	Yes	No	Yes
Efficiency	This type of air filter can theoretically remove at least 99.97% of dust, pollen, mould, bacteria and airborne particles with a size of 0.3 microns (μm). The diameter specification of 0.3 microns corresponds to the worst case – the most penetrating particle size; particles that are larger or smaller are trapped with even higher efficiency. Using the worst-case particle size results in the worst-case efficiency rating of 99.97% or better for all particle sizes		UVGI is effective in reducing the transmission of airborne bacterial and viral infections, but it has only a minimal inactivating effect on fungal spores. UVGI is also used in air-handling units to prevent or limit the growth of vegetative bacteria and fungi (25)
Suitable for air recirculation	Yes	Yes	No
Risk for health-care workers	No	No	Yes; excessive exposure may result in dermatosis and photokeratitis (26)
Electricity requirement	No	Yes	Yes
Initial cost	Moderate	High	Minimal
Ongoing operating costs	Moderate; air extractor power consumption and filter replacement according to manufacturer's specifications	Moderate; power consumption and filter replacement according to manufacturer's specifications	Minimal; air extractor power consumption and filter replacement according to manufacturer's specifications
Maintenance requirement	Moderate maintenance required by trained technicians	Moderate maintenance required by trained technicians (27); these could be in house	Minimal maintenance required; usually consists of keeping bulbs free of dust and replacing old bulbs as necessary
Merits	High efficiency	High efficiency; ventilation system included	Can be cost-effective for large facilities; minimal maintenance needed
Drawbacks	Requires uninterrupted power; requires moderate maintenance	High initial investment; requires uninterrupted power; requires moderate maintenance	Because the clinical effectiveness of UV systems may vary, UVGI is not recommended for air management before air recirculation from airborne isolation rooms; requires uninterrupted power; needs adequate infrastructure

Screening for health-care facilities

Hospitals and other health-care facilities play a critical role in national and local responses to emergencies, such as the COVID-19 epidemics. This document provides information on how these facilities can fulfil this role (28).

For the anticipation, early detection and containment response, from the introduction to the localized transmission phase, the following are recommended:

- Foresee a proper screening system at all levels of the public health system to enable early detection of potential suspected cases. This should include temporary isolation capacity, trained staff, protocols and all needed supplies.
- Designate health facilities to provide the adequate level of care, which most probably will be hospitals with available intensive care units, and set up the correct IPC and engineering measures.
- Define a clear referral pathway for suspected and confirmed cases with dedicated ambulance service to facilitate referrals from primary health centres to identified treatment facilities.
- Develop a control and mitigation plan.

This section suggests practical advice, recommendations, technical guidance and minimum requirements for setting up and operating a specific SARI screening and related waiting room, including the standards needed to repurpose an existing building into a SARI screening.

Identification, selection and survey of screening sites

The choice of a site will determine future problematic issues that could be encountered, such as infiltration, drainage, access, extension and acceptance. Take the necessary time to carefully choose the site that is as adequate as possible, rather than the first one seen.

It is important to know the average daily patient influx in order to properly size the waiting room and avoid possible overcrowding, even during the daily influx peak, which may increase the risk of nosocomial infections.

Location criteria

- Ensure the site is as close as possible to the main entrance of the health facility in order to centralize all entrances.
- Ensure good access for patients, visitors and staff, with guaranteed security.
- Aim for a unidirectional flow for all patients and visitors accessing the health facility.
- Avoid all flood areas and choose a site at least 30 m away from rivers or other bodies of water.

Ground characteristics

- Ensure the site is flat and level.
- Ensure the site is geologically stable and consolidated, preferably without organic or stony material.
- Ensure the site is easy to dig, without the danger of landslides, and with the capacity for drainage.
- Avoid areas with a high groundwater table.
- Ensure the site is of sufficient size to extend the waiting room and triage area if necessary.

Meteorological characteristics

- Be aware of seasonal periods affecting the construction (e.g. rainy/dry periods). Be able to adjust the design to accommodate different climatological conditions.

- Take into account prevailing winds for the control of smoke and odours.
- Take into account sun orientation for improved shadow zones.

Existing resources

- Consider using permanent buildings or unused existing wards.
- Evaluate water resources in the area, with special focus on the analysis of capacity, quality and availability.
- If available, have the option to connect to local basic services for water, electricity and communications.

Screening basic layout principles

The proposed layout is based on the standard screening setting endorsed with proper ventilation infection, prevention and control measures. The following assumptions are behind this layout:

- Protocols for patient screening (including the designation of screening areas) and for patient traffic flow within and in the vicinity of the hospital are available.
- Staffing is provided for newly designated hospital areas, such as the new screening area and isolation room.
- The hospital applies screening criteria with a view to admitting the most critically ill patients and treatable epidemic patients. In some circumstances, health authorities may require a health facility to focus on providing health services to non-epidemic patients and to refer epidemic patients elsewhere.

This document aims to present different structural approaches to set up a waiting room and triage area specifically adapted for COVID-19 in the following situations:

- New-construction concrete building or semi-permanent structure; the standards proposed here can also be used to repurpose existing buildings.
- Large tent (> 100 m²), as commonly used in emergency settings by humanitarian actors, institutions and United Nations agencies to set up warehouses and high-capacity shelters.
- Standard-sized tent (about 45 m²), as commonly used by humanitarian actors, institutions and United Nations agencies for emergency responses.

Screening in new health-care facilities

Screening is divided into two distinctive zones: one zone for staff and one zone for patients (Figures 17–19). A distance of 2 m between staff and patients is required.¹ Double fencing or a Plexiglas barrier can be used for the separation. Separate handwashing points (soap/water) are required for patients and staff.

The screening building could be a temporary structure, a repurposed existing building, or a simple tent (see Annex 16). Natural ventilation and exhausted air dilution should be ensured. Note that staff should not wear masks in the screening area, except when in contact with patients.

¹ Recommended spatial distance for IPC is 1 metre. However, in order to facilitate access and movement of health-care workers, 2 metres separation is advised.

Figure 17. Screening area in a severe acute respiratory infection treatment centre

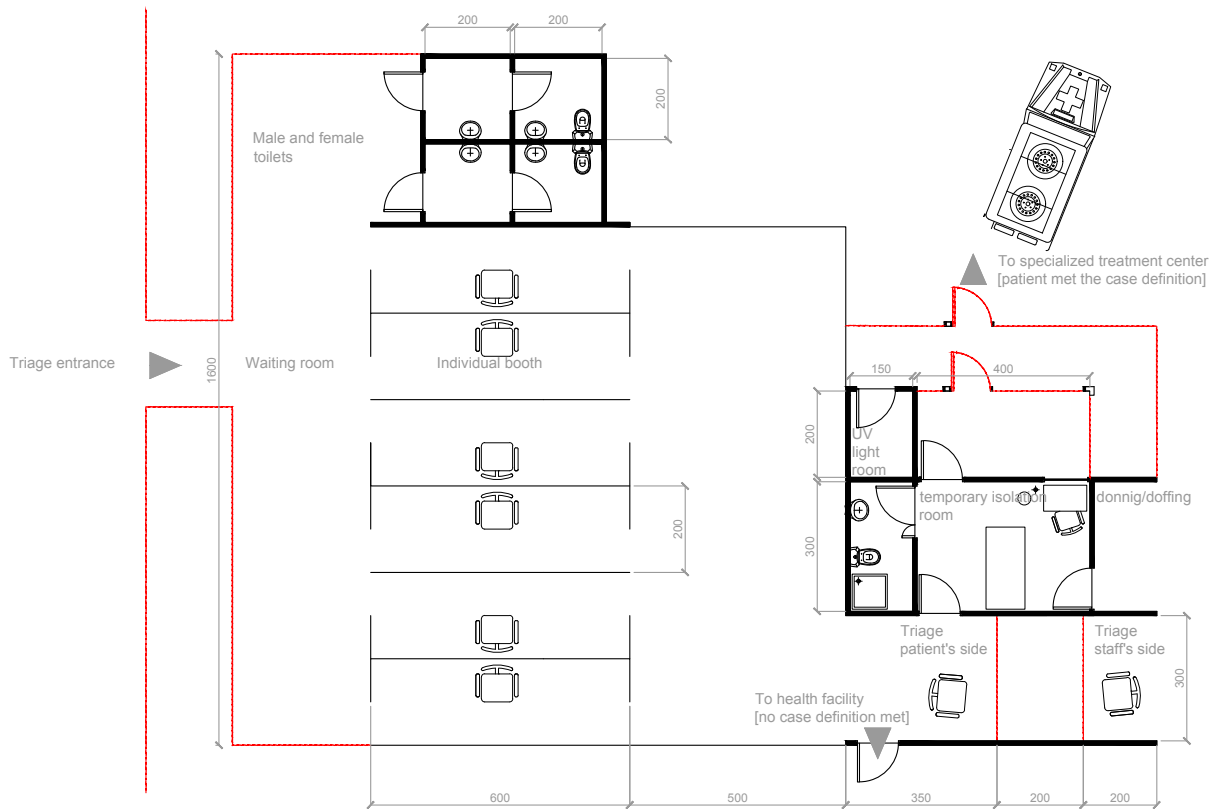

Figure 18. Services and facilities in the screening area of a severe acute respiratory infection treatment centre

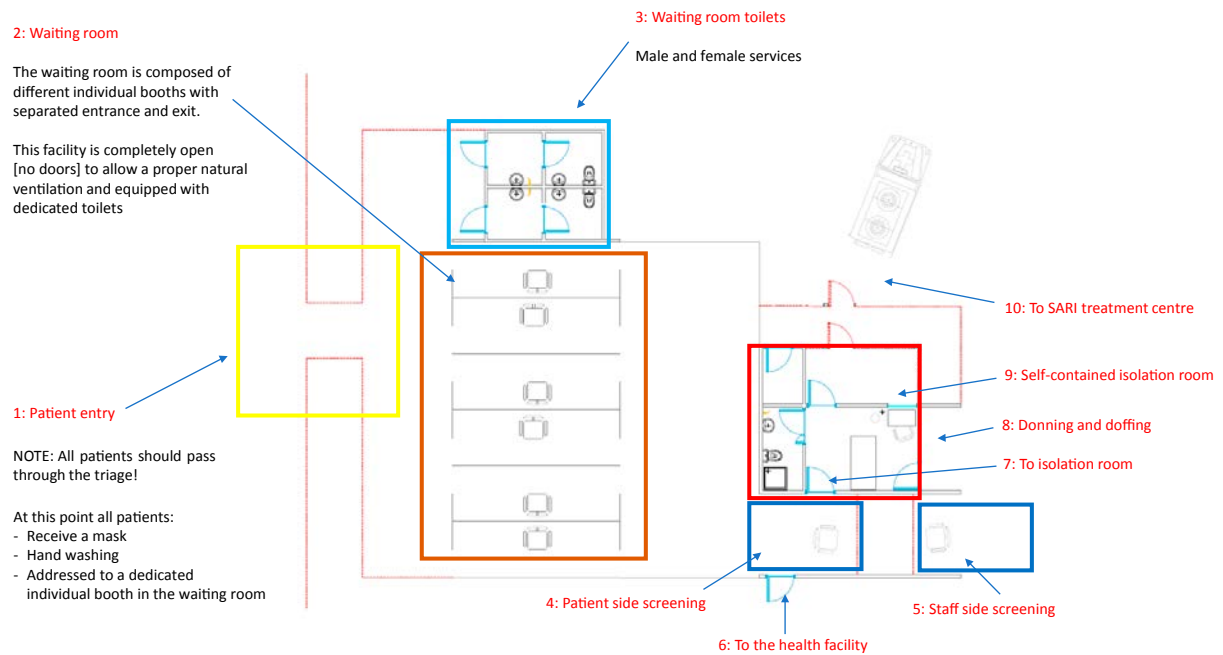
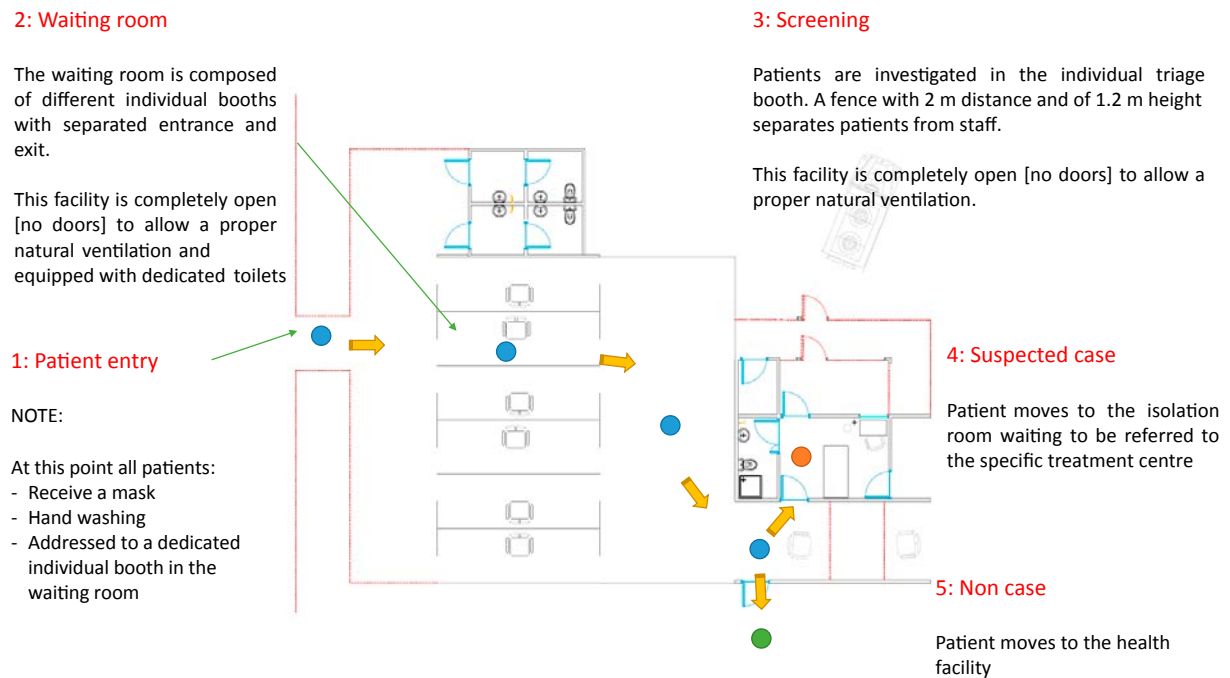

Figure 19. Flow of patients in the screening area of a severe acute respiratory infection treatment centre



Waiting room

The waiting room should be composed of individual booths open on both sides to ensure proper natural ventilation. Each booth should be clearly identified and labelled to avoid mistakes and allow patient flow. Booths should be cleaned and disinfected after each patient to avoid nosocomial infections. If individual booths are not available, ensure a distance of at least 2 m between patients.²

Isolation room

The isolation room is a temporary area for a person suspected of being infected to wait for an ambulance or referral. If there is no isolation capacity, an ambulance could be held in standby near the screening area in order to allow rapid referral.

If needed, sampling can be done in the temporary isolation room.

Establishing a screening area in a tent

The lack of an existing building to be repurposed or the need to set up a screening area as quickly as possible may lead to using a tent as this is quicker than building a semi-permanent structure and cheaper than building a concrete structure. It is essential to respect all the IPC requirements in terms of distance between patients and proper flows.

Figures 20 and 21 show examples of how a tent could be used to set up a waiting room and screening area. If a single tent with a surface area greater than 100 m² is not available, then several smaller tents can be used and the waiting room space split between them, according to specific setting needs. Consider installing handwashing points at patient's and staffs' entrance and exit. Dedicated toilets for patients in the waiting room should be available, with a related handwashing point.

² Recommended spatial distance for IPC is 1 metre. However, in order to facilitate access and movement of health-care workers, 2 metres separation is advised.

In cold-weather countries it is possible to replace natural ventilation with a mechanical or hybrid system with specific exhausted air treatment or a portable air filtration system, sized according to the capacity of the waiting room (airflow 60 l/s/person).

Figure 20. Example of a waiting room and screening area within a tent with a surface area over 100 m²

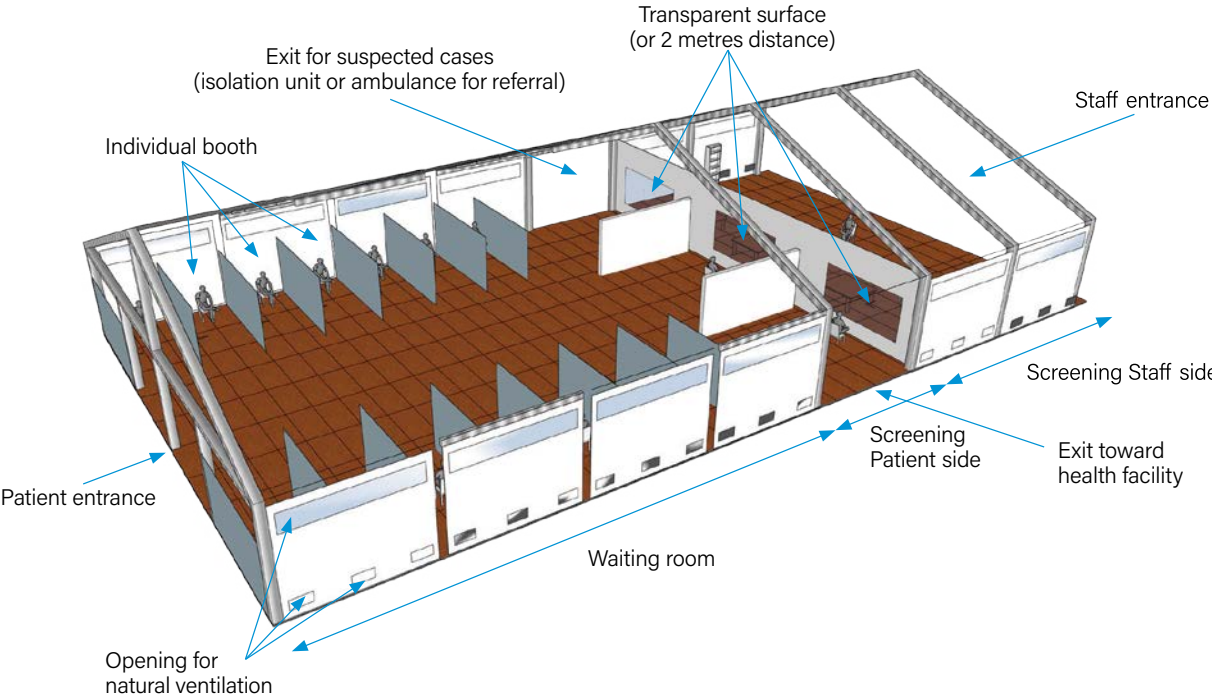
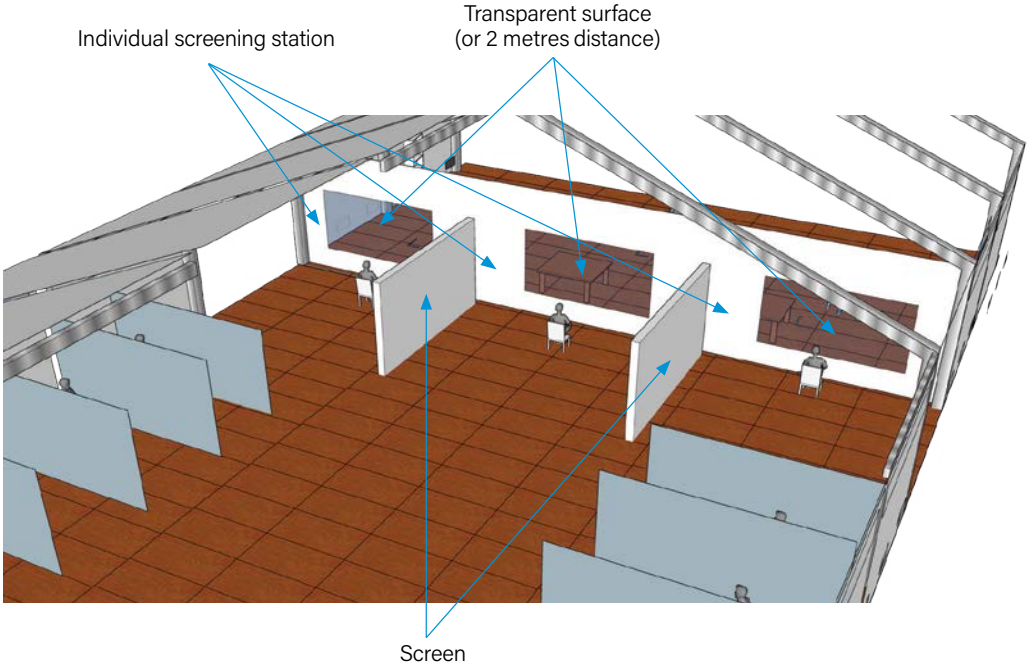
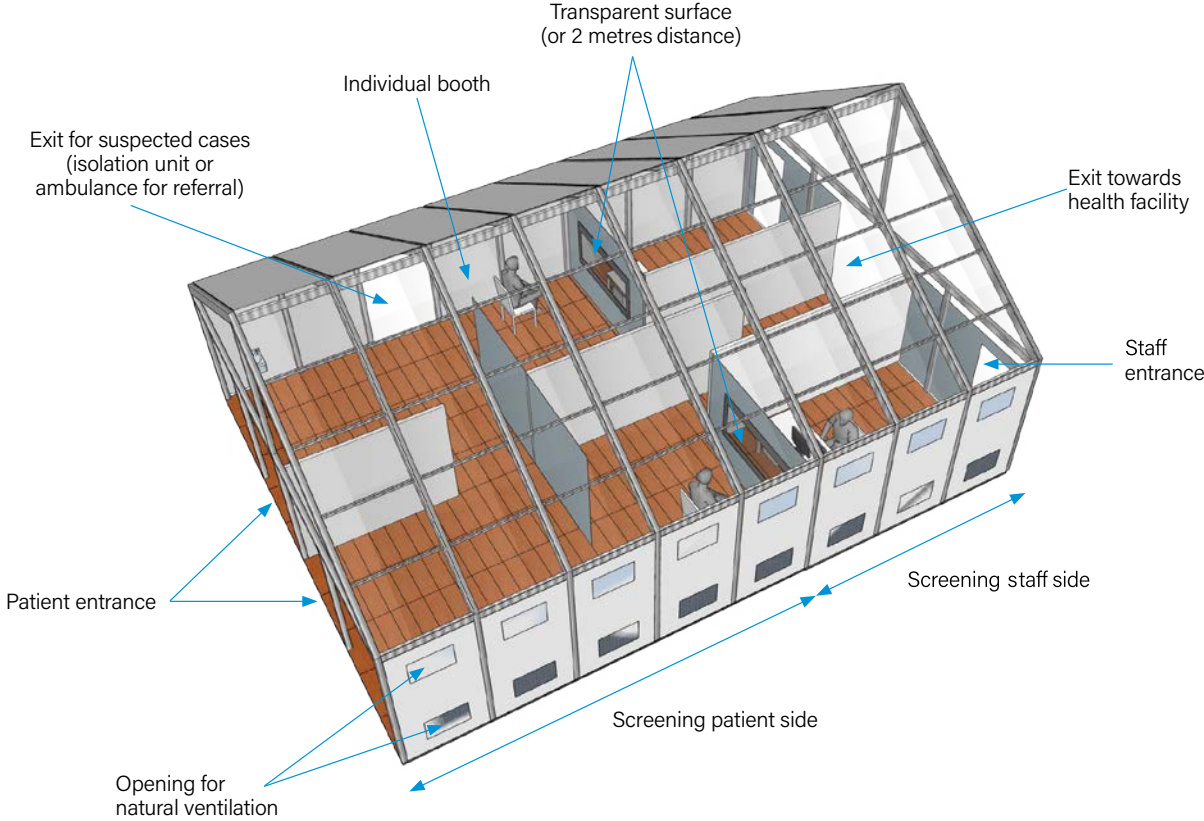

Figure 21. Example of a screening area (patient side) within a tent with a surface area over 100 m²



Small tents allow more flexibility in terms of capacity (Figure 22). If required by the epidemiological situation, installing more tents to increase the waiting room capacity or installing a second screening tent can be done easily. Internal separation (screens) can be ensured with wooden frames folded with washable plastic sheeting. The transparent surface for screening can be replaced by a distance of 2 m properly marked, such as a double 1.1 m fence.

Figure 22. Example of a waiting room and screening area within a tent with a surface area of about 45 m²



Small tents can be used as waiting rooms. Figure 23 shows a standard 45 m² tent divided into 10 individual booths for patients waiting to access the screening area.

Figure 23. Standard 45 m² tent divided into 10 individual booths for patients waiting to access the screening area

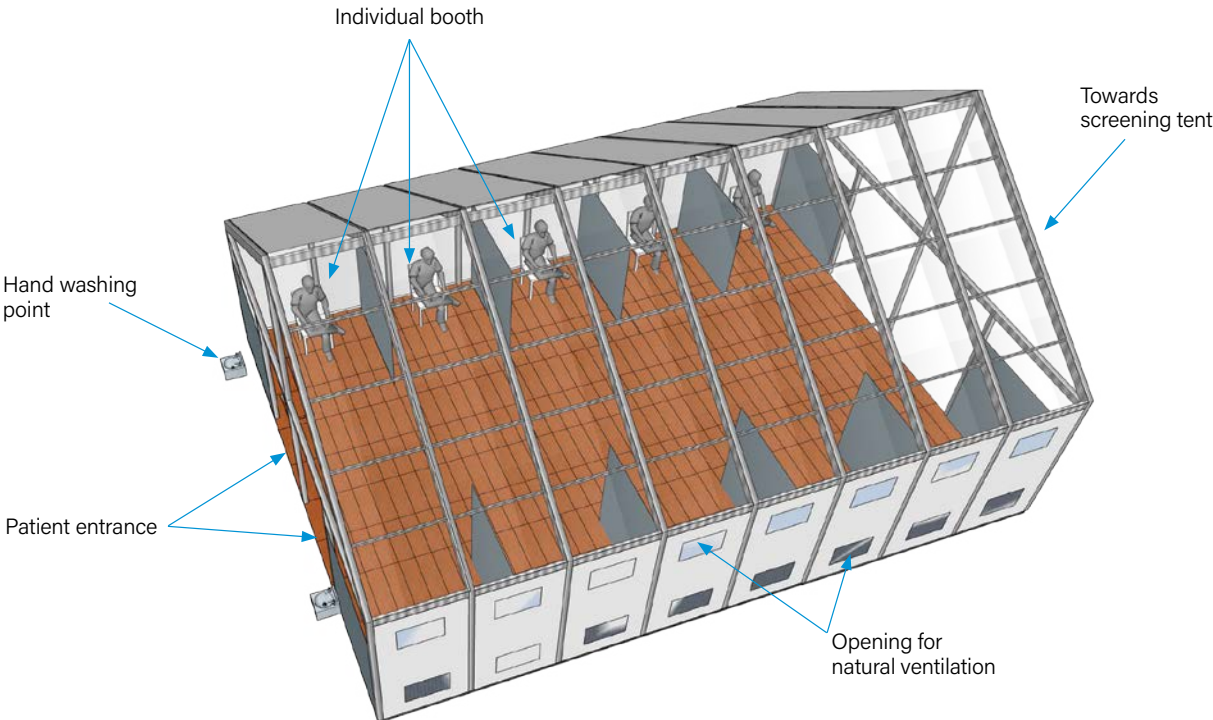

Screening and waiting room tents should be installed correctly to allow clear patient flow, as shown in Figure 24.

Figure 24. Example of patient flow within tent-based screening areas

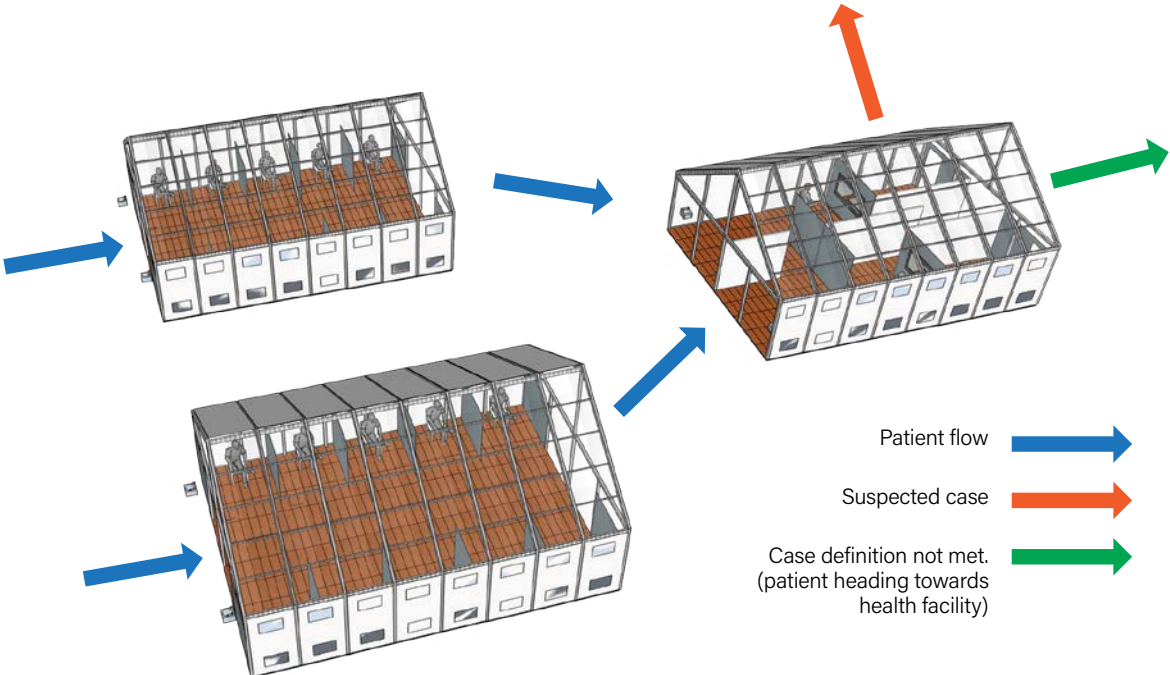

SARI treatment centre

Site identification, selection and survey

The choice of a site will determine future problematic issues that could be encountered, such as infiltration, drainage, access, extension and acceptance. Take the necessary time to carefully choose the site that is as adequate as possible, rather than the first one seen.

It is important to define the expected potential scale (e.g. size, duration) of the outbreak from the beginning.

Location criteria

- Ensure good access and guaranteed security for patients, visitors and staff.
- Ensure proximity to the outbreak epicentre.
- Ensure proximity to existing health-care facilities to facilitate external referral pathways for people who test negative for 2019-nCoV but who require medical care for different medical conditions.
- Avoid all flood areas and choose a site at least 30 metres away from rivers and other bodies of water.

Ground characteristics

- Ensure the site is flat and level.
- Ensure the site is geologically stable and consolidated, preferably without organic or stony material.
- Ensure the site is easy to dig, without the danger of landslides, and with the capacity for drainage.
- Avoid areas with a high groundwater table.
- Choose a sufficiently large plot of land so the centre can be extended if necessary.

Meteorological characteristics

- Be aware of seasonal periods affecting the construction (e.g. rainy/dry periods). Be able to adjust the design to accommodate different climatological conditions.
- Take into account prevailing winds for the control of smoke and odours.
- Take into account sun orientation for improved shadow zones.

Existing resources

- Consider the use of permanent buildings and existing hospital isolation or unused wards.
- Evaluate water resources in the area, with special focus on the analysis of capacity, quality and availability.
- If available, have the option to connect to local basic services for water, electricity and communications.
- Before arrival of main supplies, prepare or identify a storage area.

Basic layout

The proposed layout is based on the clinical definition of a person with SARI, suspected nCoV, the clinical syndromes associated with nCoV infection, and related medical condition categories: mild, moderate, severe and critical illness.

Figure 25. Basic layout of severe acute respiratory infection treatment centre

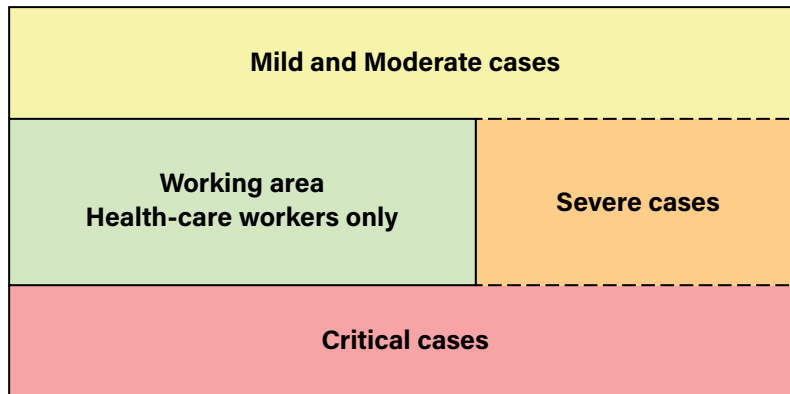

The rationales behind this layout are as follows:

- Medical care should be provided as soon as possible, even before laboratory confirmation, in order to avoid medical conditions worsening.
- People with different medical conditions present different risks; for example, people with severe SARI might need an aerosol-generating procedure.
- Ensure a clear demarcation and separation between patient and staff areas in order to reduce the risk for health-care workers and allow a rational use of PPE.
- The centre should be divided into two zones – a staff area for health-care workers and a patients' area (Figures 25 and 26). The patients' area is further divided into three zones (mild and moderate, severe and critical) according to the medical conditions of the patients. Patient categorization should follow the definition of clinical syndromes associated with nCoV infection (Table 10) (29). It is the responsibility of the case management department to decide on categorization (30).

Figure 26. Severe acute respiratory infection treatment centre zone categorization

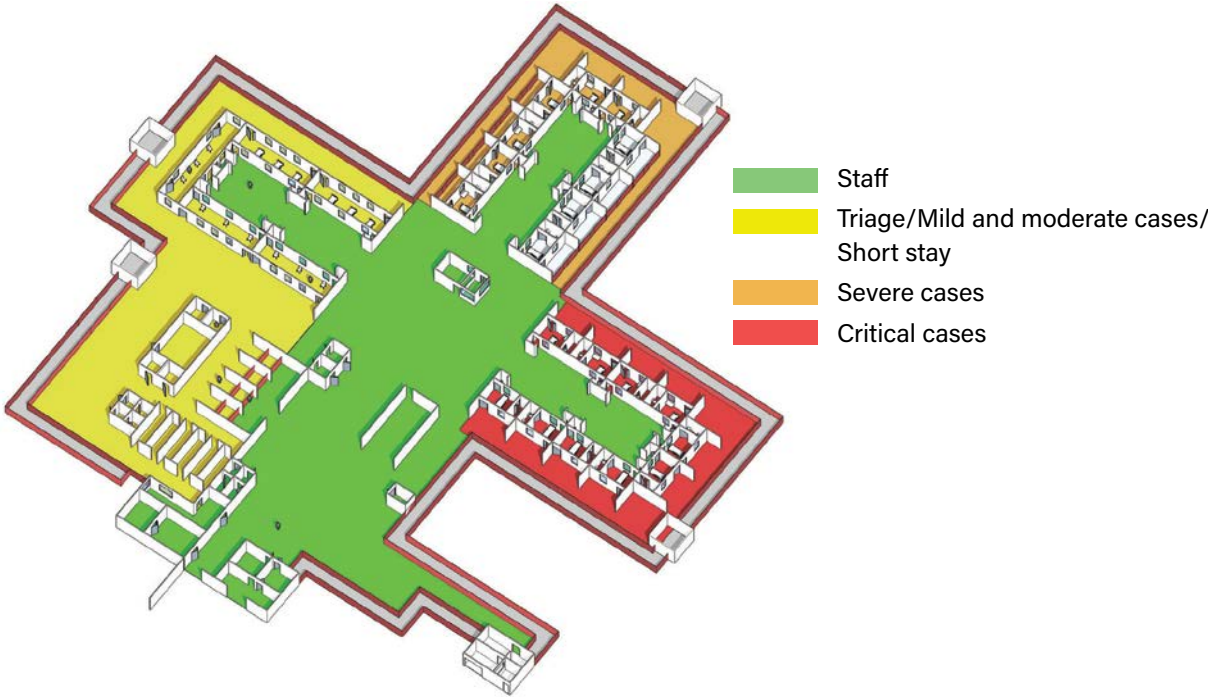

Table 10. Categorization of patients with severe acute respiratory infection

Mild and moderate	Uncomplicated illness	<p>Uncomplicated upper respiratory tract viral infection; people may have non-specific symptoms such as fever, cough, sore throat, nasal congestion, malaise, headache or muscle pain</p> <p>Elderly people and people with immunosuppression may present with atypical symptoms</p> <p>These patients do not have any signs of dehydration, sepsis or shortness of breath</p>
	Mild pneumonia	<p>Pneumonia but no signs of severe pneumonia</p> <p>Child: cough or difficulty breathing and fast breathing (age < 2 months, ≥ 60 breaths/min; age 2–11 months, ≥ 50 breaths/min; age 1–5 years, ≥ 40 breaths/min) and no signs of severe pneumonia</p>
Severe	Severe pneumonia	<p>Adolescent or adult: fever or suspected respiratory infection, plus one of: respiratory rate > 30 breaths/min, severe respiratory distress, or SpO₂ < 90% on room air (1)</p> <p>Child: cough or difficulty in breathing, plus at least one of: central cyanosis or SpO₂ < 90%; severe respiratory distress (e.g. grunting, very severe chest indrawing); signs of pneumonia with a general danger sign (inability to breastfeed or drink, lethargy or unconsciousness, convulsions)</p> <p>Other signs of pneumonia may be present: chest indrawing, fast breathing (age < 2 months, ≥ 60 breaths/min; age 2–11 months, ≥ 50 breaths/min; age 1–5 years, ≥ 40 breaths/min (2))</p> <p>Diagnosis is clinical; chest imaging can exclude complications</p>

Critical	Acute respiratory distress syndrome	<p>Onset: new or worsening respiratory symptoms within one week of known clinical insult</p> <p>Chest imaging (radiograph, CT scan, lung ultrasound): bilateral opacities not fully explained by effusions, lobar or lung collapse, or nodules</p> <p>Origin of oedema: respiratory failure not fully explained by cardiac failure or fluid overload; need objective assessment (e.g. echocardiography) to exclude hydrostatic cause of oedema if no risk factors present</p> <p>Oxygenation (adult):</p> <ul style="list-style-type: none"> Mild acute respiratory distress syndrome: $200 \text{ mmHg} < \text{PaO}_2/\text{FiO}_2 \leq 300 \text{ mmHg}$ with PEEP or CPAP $\geq 5 \text{ cmH}_2\text{O}$ (7) or non-ventilated (8) Moderate acute respiratory distress syndrome: $100 \text{ mmHg} < \text{PaO}_2/\text{FiO}_2 \leq 200 \text{ mmHg}$ with PEEP $\geq 5 \text{ cmH}_2\text{O}$ (7) or non-ventilated (8) Severe acute respiratory distress syndrome: $\text{PaO}_2/\text{FiO}_2 \leq 100 \text{ mmHg}$ with PEEP $\geq 5 \text{ cmH}_2\text{O}$ (7) or non-ventilated (8) When PaO_2 is not available, $\text{SpO}_2/\text{FiO}_2 \leq 315$ suggests acute respiratory distress syndrome (including in non-ventilated patients) <p>Oxygenation (child):</p> <ul style="list-style-type: none"> Bilevel non-invasive ventilation or CPAP $\geq 5 \text{ cmH}_2\text{O}$ via full face mask: $\text{PaO}_2/\text{FiO}_2 \leq 300 \text{ mmHg}$ or $\text{SpO}_2/\text{FiO}_2 \leq 264$ Mild acute respiratory distress syndrome (invasively ventilated): $4 \leq \text{OI} < 8$ or $5 \leq \text{OSI} < 7.5$ Moderate acute respiratory distress syndrome (invasively ventilated): $8 \leq \text{OI} < 16$ or $7.5 \leq \text{OSI} < 12.3$ Severe acute respiratory distress syndrome (invasively ventilated): $\text{OI} \geq 16$ or $\text{OSI} \geq 12.3$
	Sepsis	<p>Adult: life-threatening organ dysfunction caused by dysregulated host response to suspected or proven infection, with organ dysfunction. Signs include altered mental status, difficult or fast breathing, low oxygen saturation, reduced urine output, fast heart rate, weak pulse, cold extremities, low blood pressure, skin mottling, or laboratory evidence (coagulopathy, thrombocytopenia, acidosis, high lactate, hyperbilirubinemia)</p> <p>Child: suspected or proven infection and two or more systemic inflammatory response syndrome criteria, of which one must be abnormal temperature or white blood cell count</p>
	Septic shock	<p>Adult: persisting hypotension despite volume resuscitation, requiring vasopressors to maintain mean arterial pressure $\geq 65 \text{ mmHg}$ and serum lactate level $> 2 \text{ mmol/L}$</p> <p>Child: any hypotension (systolic blood pressure $< 5\text{th}$ centile or > 2 standard deviations below normal for age) or two or three of: altered mental state; tachycardia or bradycardia (infant: heart rate $< 90 \text{ beats/min}$ or $> 160 \text{ beats/min}$; child: heart rate $< 70 \text{ beats/min}$ or $> 150 \text{ beats/min}$); prolonged capillary refill ($> 2 \text{ s}$) or warm vasodilation with bounding pulses; tachypnoea; mottled skin or petechial or purpuric rash; increased lactate; oliguria; hyperthermia or hypothermia (30)</p>

CPAP, continuous positive airway pressure; OI, oxygenation index; OSI, oxygenation index using SpO_2 ; PEEP, positive end-expiratory pressure.

Minimum requirements for converting an existing building into a severe acute respiratory infection treatment centre

An existing building may be repurposed into a SARI treatment centre if the minimum requirements are met:

- minimum ventilation rate of 60 litres per second per patient for mild and moderate wards;
- minimum ventilation rate of 160 litres per second per patient for severe wards and intensive care units;
- airflow from clean to dirty zones;
- patient and staff flow can be clearly defined and distances respected;
- all finishes, furniture and patient care equipment can be effectively cleaned and are compatible with the facility’s disinfectants (see below).

Recommended characteristics for selecting finishes and furniture

The recommended characteristics for selecting finishes and furniture are summarized in Table 11 (32).

Table 11. Recommended characteristics for selecting finishes and furniture for a severe acute respiratory infection treatment centre

Characteristic	Selection guidance
Cleanable	<ul style="list-style-type: none"> ▪ Avoid items with hard-to-clean features, such as crevasses ▪ Do not use carpets in patient care areas ▪ Select material that can withstand repeated cleaning
Easy to maintain and repair	<ul style="list-style-type: none"> ▪ Avoid materials prone to cracks, scratches or chips, and quickly patch or repair if they do occur ▪ Select materials that are durable or easy to repair
Resistant to microbial growth	<ul style="list-style-type: none"> ▪ Avoid materials that hold moisture, such as wood and cloth, as these facilitate microbial growth ▪ Select metals and hard plastics
Nonporous	<ul style="list-style-type: none"> ▪ Avoid items with porous surfaces, such as cotton, wood and nylon ▪ Avoid porous plastics, such as polypropylene, in patient care areas
Seamless	<ul style="list-style-type: none"> ▪ Avoid items with seams ▪ Avoid upholstered furniture in patient care areas

Layout

Figures 27–33 show the ideal layout and flows for patients and staff for a SARI treatment centre.

Figure 27. Layout of services and facilities in a severe acute respiratory infection treatment centre

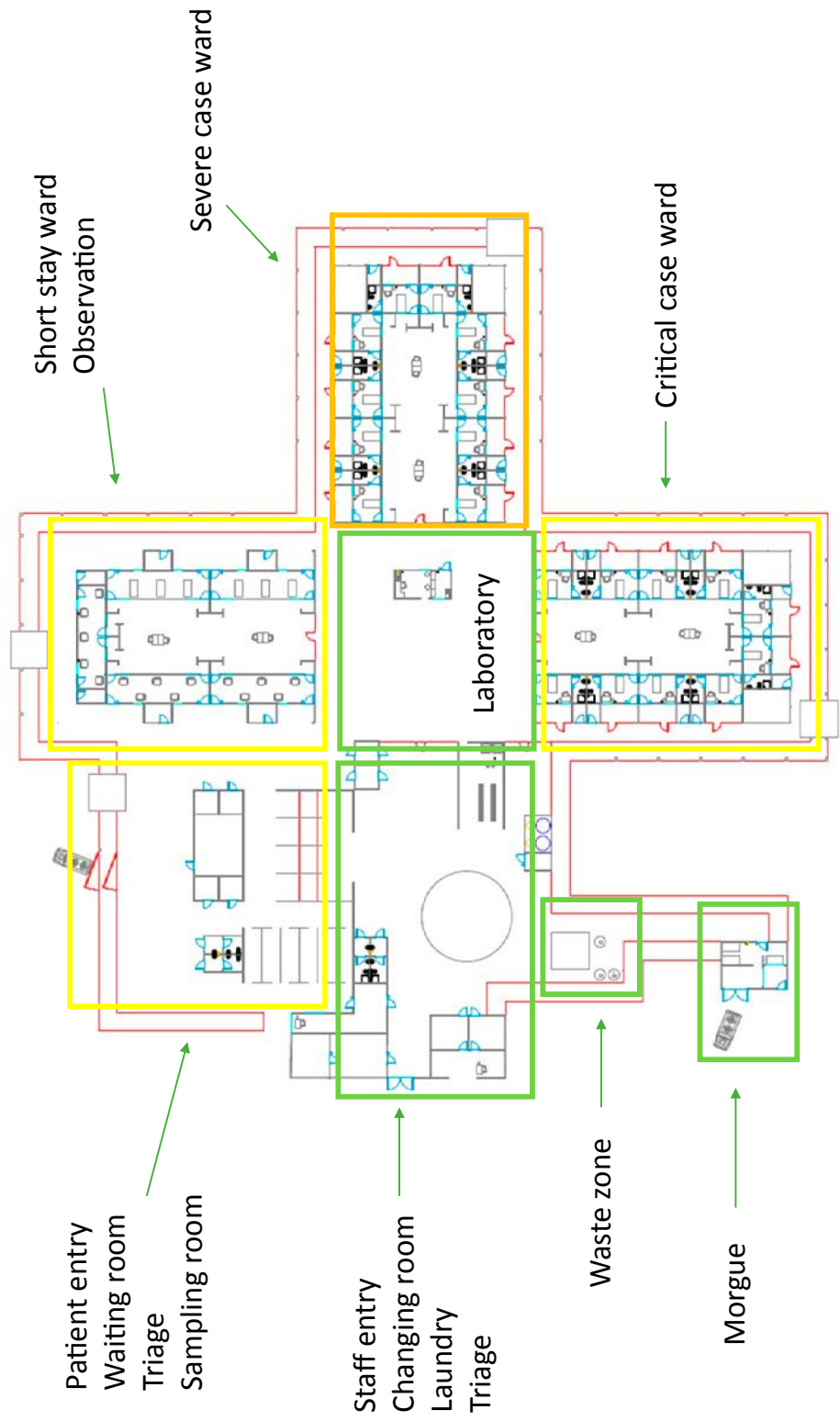

Figure 28. Patient flow, from entry to sampling, in a severe acute respiratory infection treatment centre

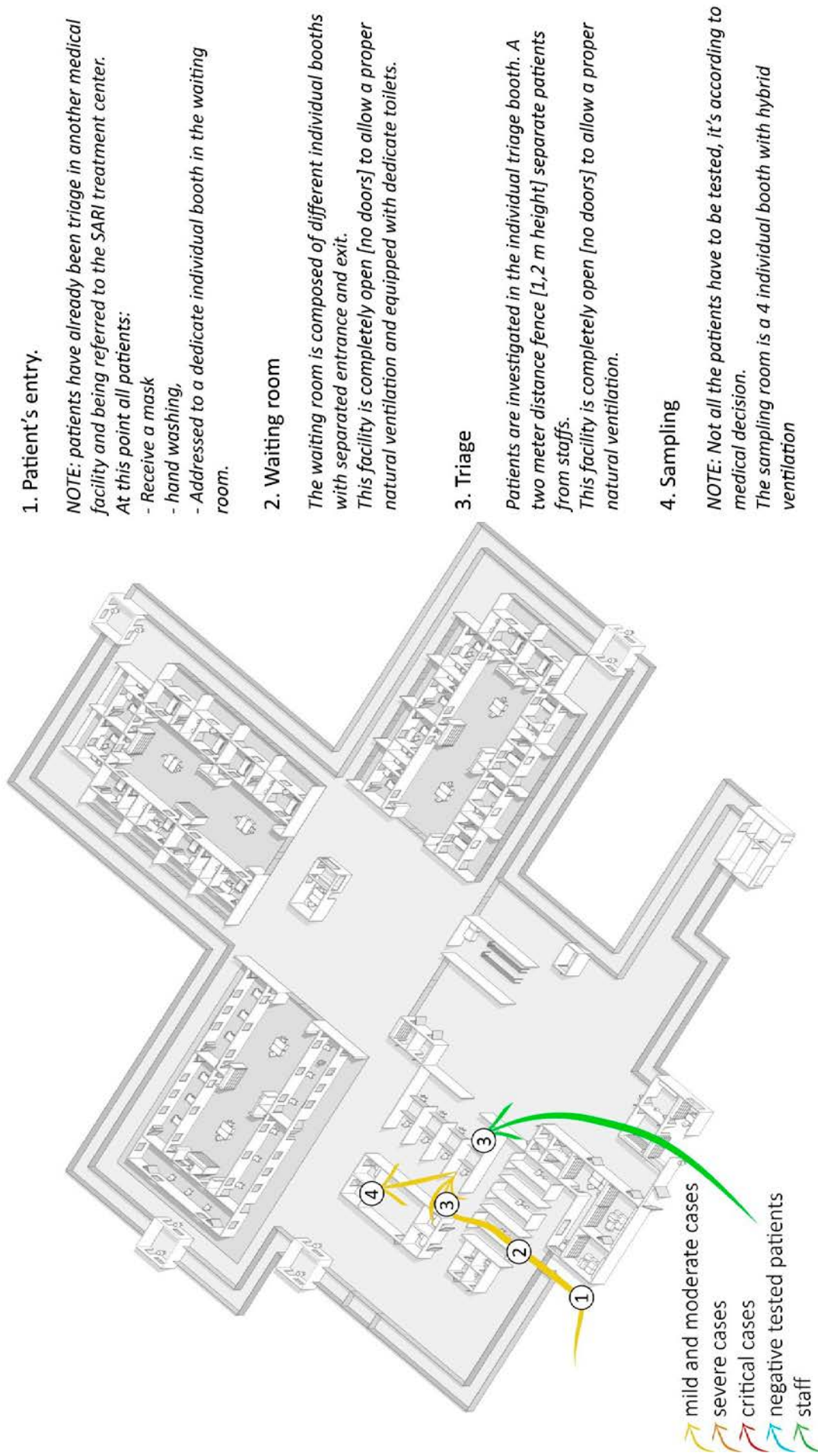

Figure 29. Patient flow after sampling patients are divided by severity in a severe acute respiratory infection treatment centre

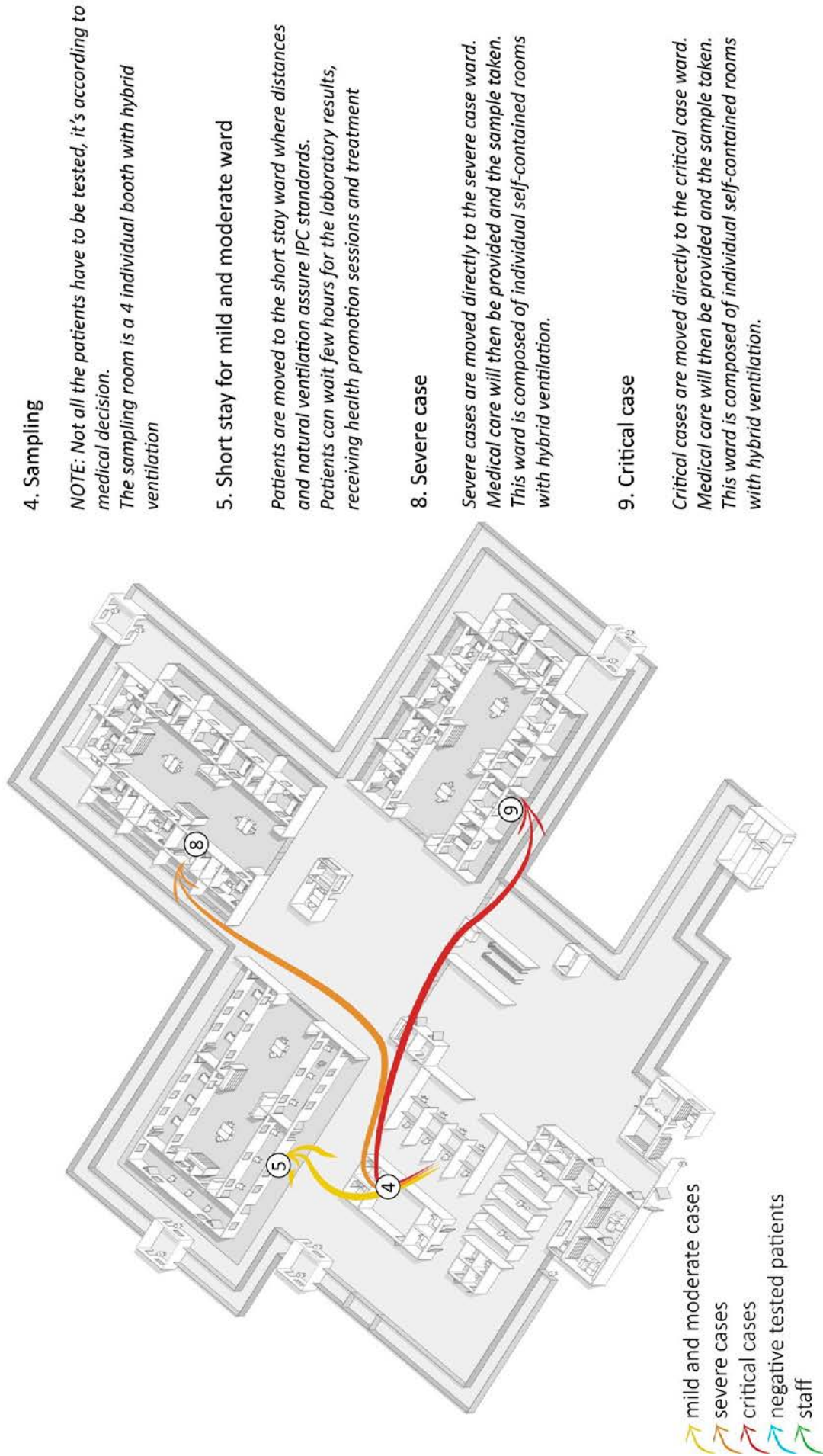

Figure 30. Patient flow for negative, mild and moderate respiratory infection treatment centre

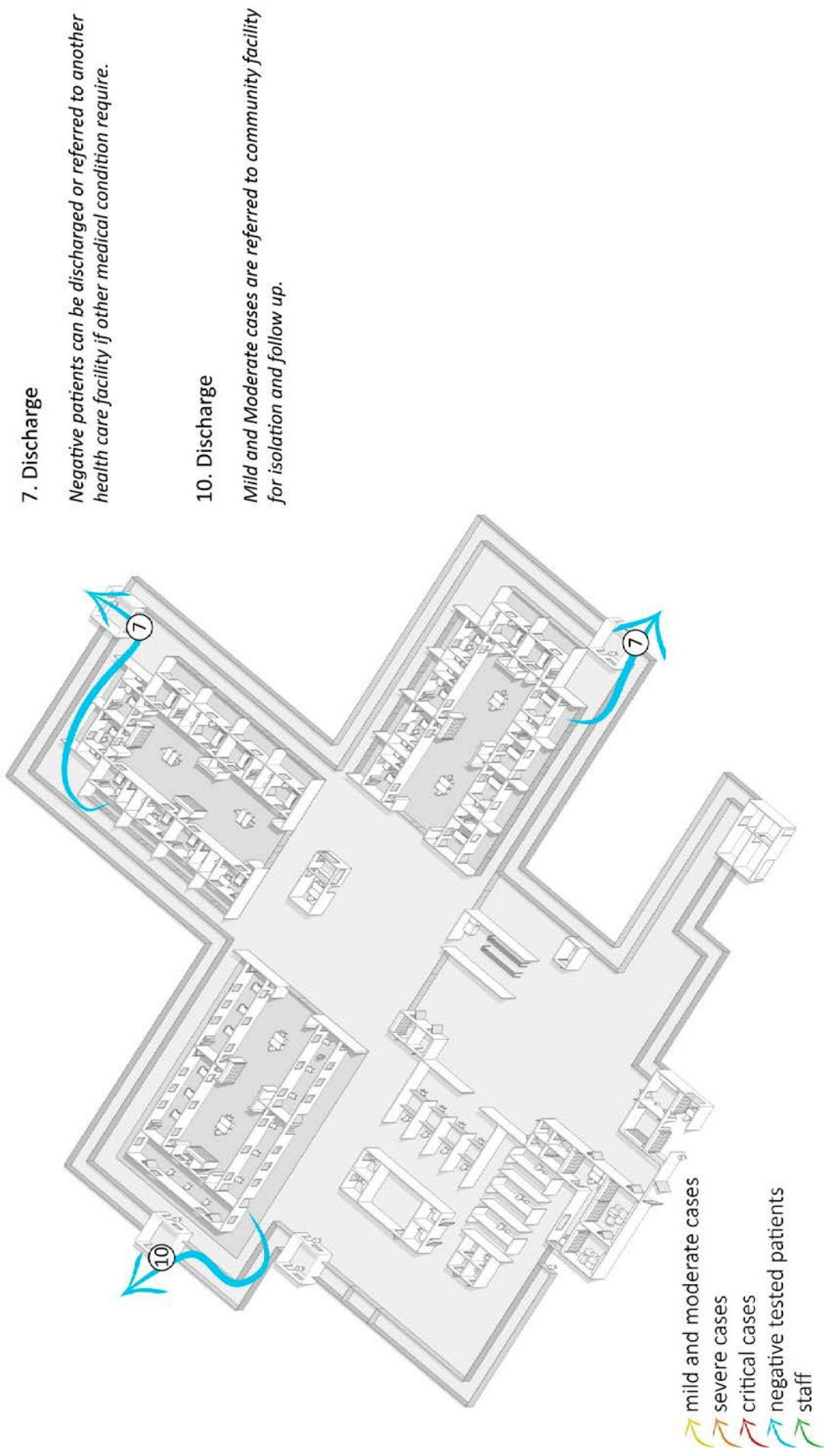

Figure 31. Patient flow for worsening patients in a severe acute respiratory infection treatment centre

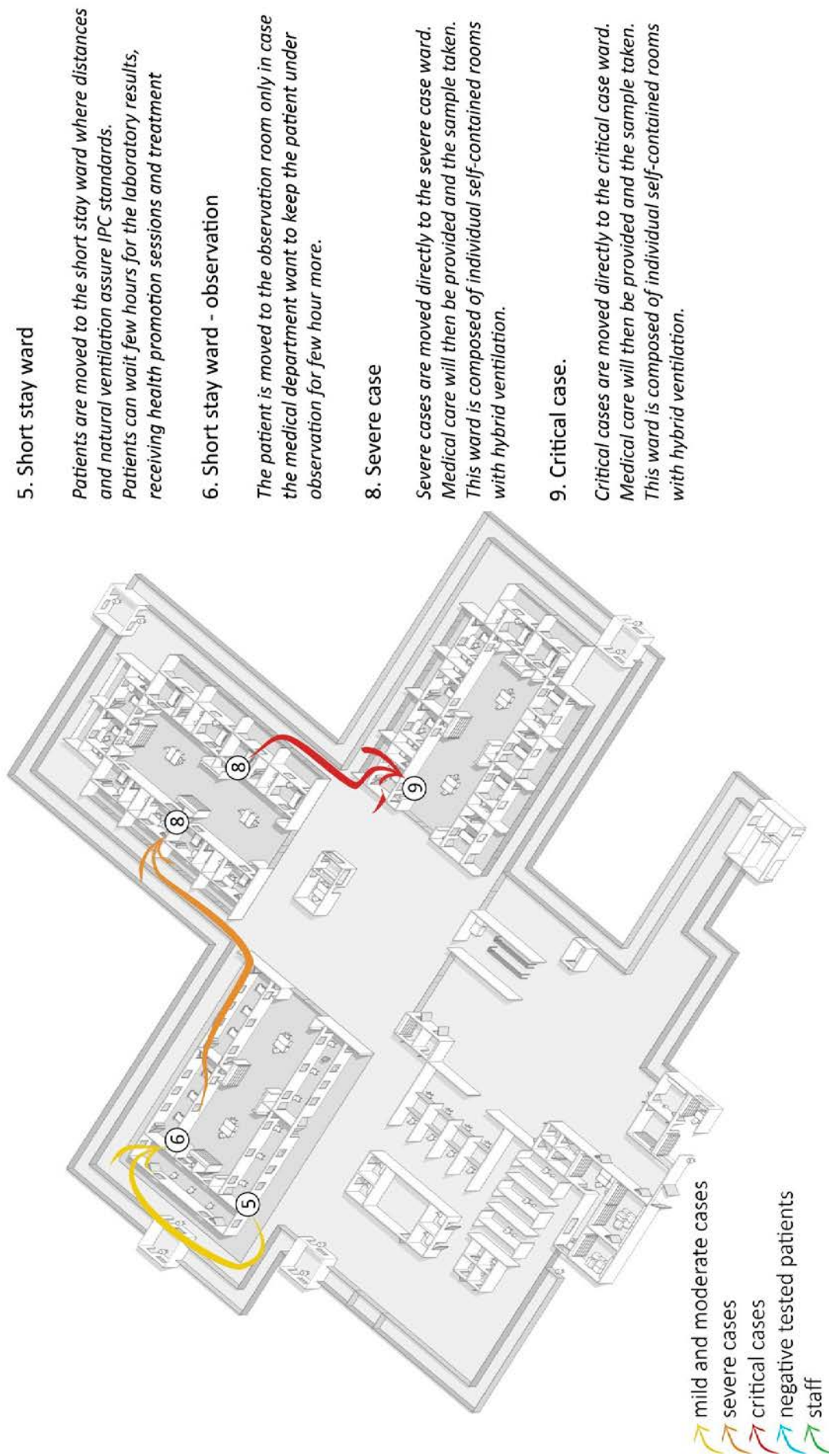

Figure 32. Patient flow for recovering patients in a severe acute respiratory infection treatment centre

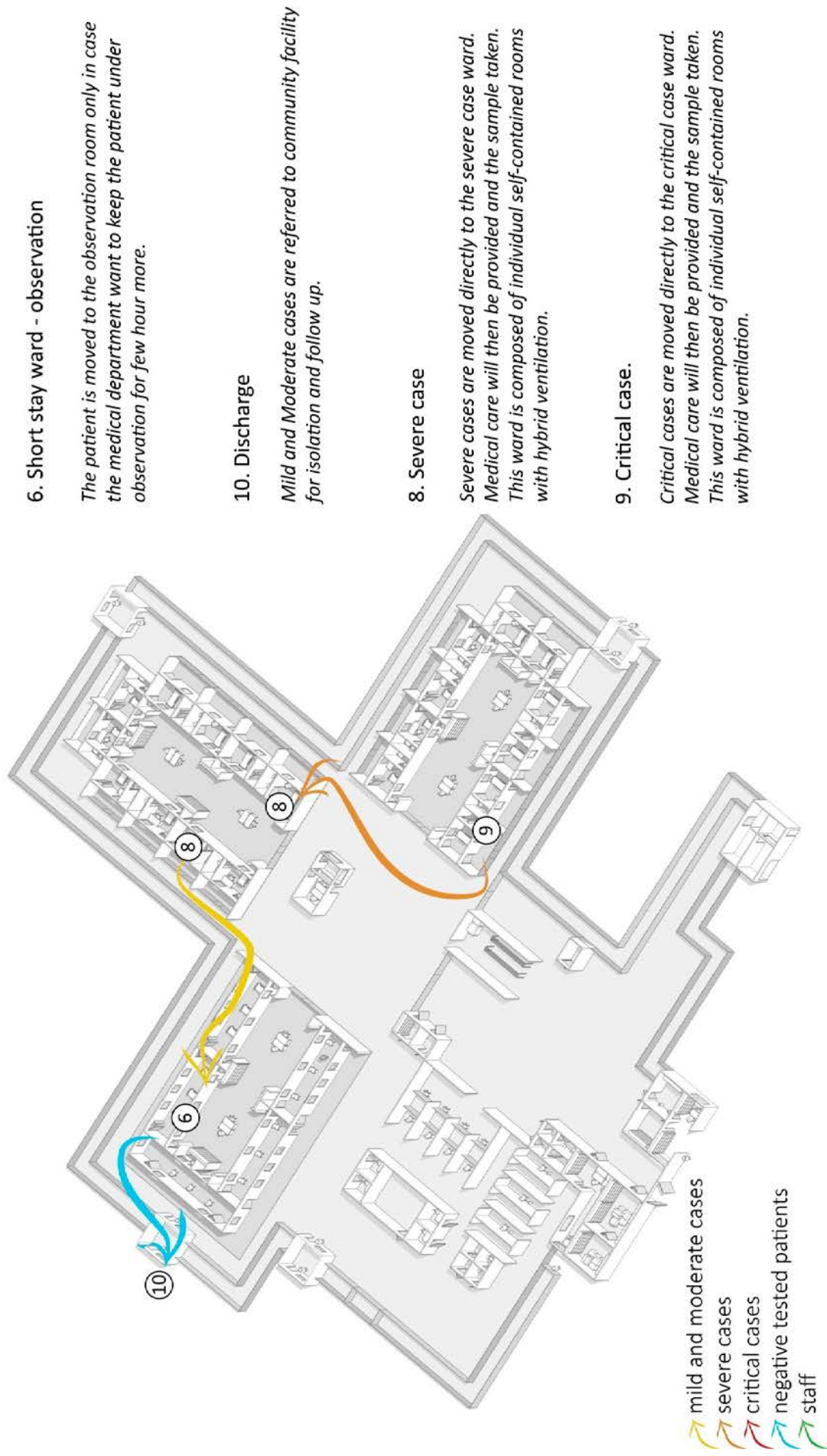
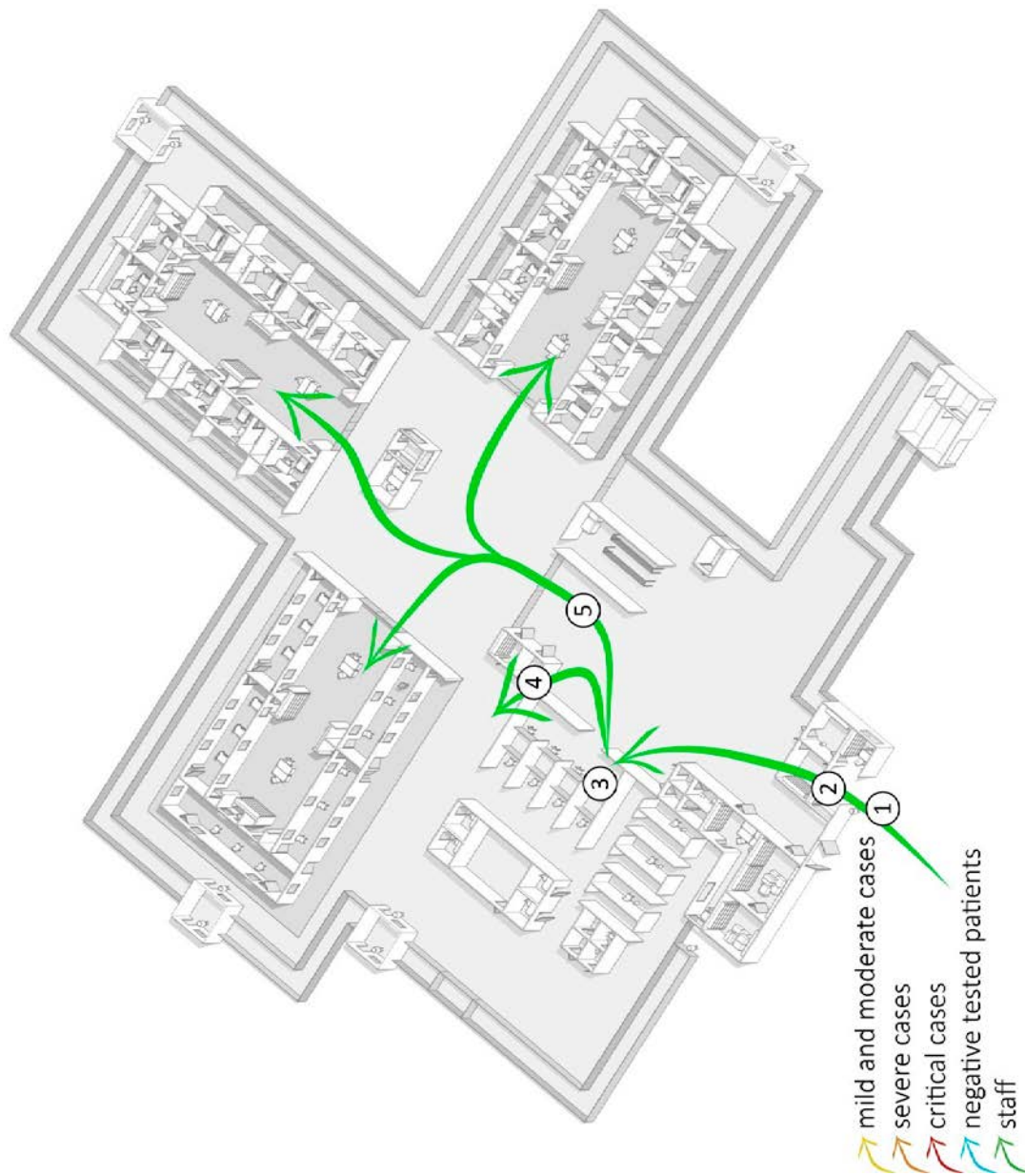

Figure 33. Staff flow in a severe acute respiratory infection treatment centre



1. Staff entry

At this point all staff: Receive a mask:

- Hand washing,
- Temperature check
- Presence record

2. Changing room

Male and female changing room to remove personal clothes and wear scrubs and boots [or closed shoes]. Staff toilets are available nearby.

3. Triage

Patients are investigated in the individual triage booth. A fence with 2 m distance and of 1.2 m height separates patients from staff. This facility is completely open [no doors] to allow a proper natural ventilation.

4. Triage - Donning/Doffing

Staff can wear specific PPE before going to the patient at the triage.

5. Wards - staff area

Each ward is equipped with a working space for staff where patients are not allowed. More information in the next chapter.

Facilities and services

Staff entrance and changing room

The staff entrance (Figure 34) is the first IPC administrative control as it allows temperature screening of staff members. The receptionist should have good visibility to avoid unauthorized people from entering and should ensure handwashing of all people entering. Hand hygiene points with soap/running water or alcohol hand rub should be available in all rooms. The entrance should be spacious enough to avoid potential overcrowding at certain hours (e.g. shift changes). Ensure natural ventilation with wide, open windows. Consider installing shelves for staff members' personal items.

Male and female changing rooms should be spacious enough to avoid overcrowding during shift changes and should be equipped with shelves for scrubs, boots or closed shoes for cleaners, and personal clothes. Ensure adequate natural ventilation or using air extractors and a wind tower.

Figure 34. Staff entrance and changing room in a severe acute respiratory infection treatment centre

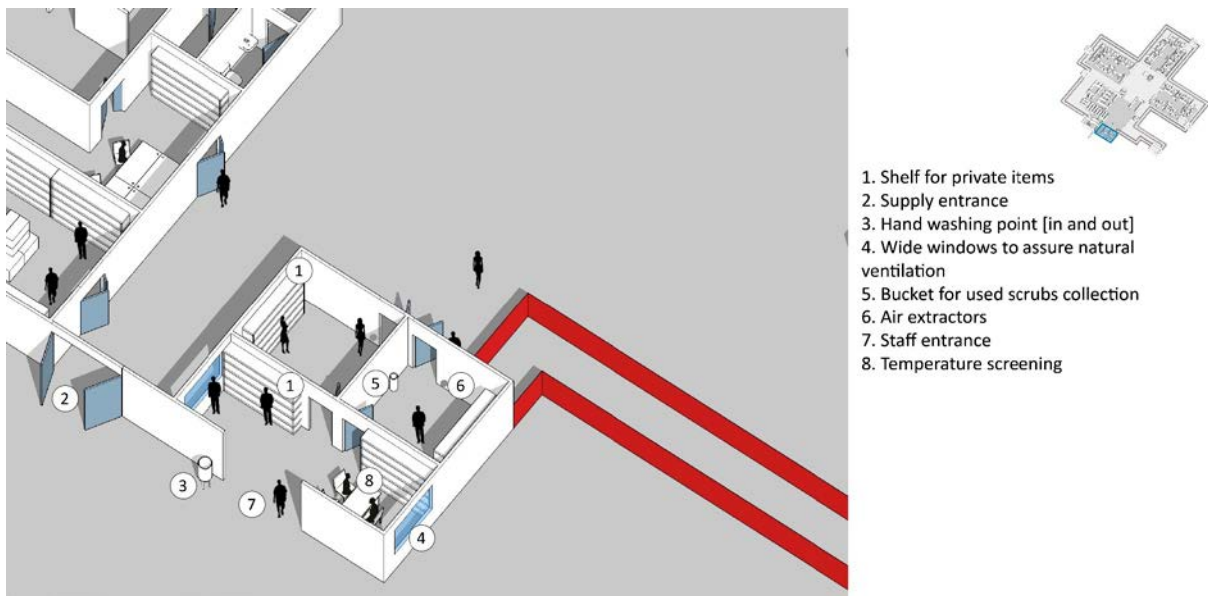

Staff should not wear masks in the centre except when in contact with patients.

Triage area

Triage is divided into two distinctive zones: a zone for staff and a high-risk zone for patients (Figure 35). A distance of 1 m between staff and patients is required. Double fencing or a Plexiglas barrier can be used for separation. Separate handwashing points (soap and water) are required for patients and staff. A sloping board or slide can be placed between staff and patient zones to pass items (e.g. thermometers) from the staff area to the patient zone.

Figure 35. Triage area in a severe acute respiratory infection treatment centre



Reception

Reception is a key service as the receptionist will have to direct the patient to the correct waiting booth (empty, cleaned and disinfected). Strong communication between the receptionist and triage staff is needed to ensure proper patient flow.

Waiting room

The waiting room is composed of individual booths open on both sides to ensure proper natural ventilation. Each booth should be clearly identified and labelled to avoid mistakes and allow proper patient flow. Booths should be cleaned and disinfected after each patient to avoid nosocomial infections.

Sampling room

This is where samples are taken for mild and moderate cases. Use individual booths with natural ventilation/dilution or hybrid ventilation and a HEPA filter for the exhaust air. Each booth should be clearly identified and labelled to avoid mistakes and allow proper patient flow. Booths should be cleaned and disinfected after each patient to avoid nosocomial infections.

Note that sampling of a patient is based on a case management decision.

Discharge room

This is for patients who do not fit the case definition or for mild and moderate cases referred to community facilities or homecare. There should be a wide window on both sides to ensure adequate natural ventilation. Handwashing points must be available at the entrance and exit. A member of staff should always be present to control movements.

Short-stay mild and moderate wards

Figure 36 demonstrates a short-stay or moderate ward. Note that windows are opened on the outside but closed with transparent material such as Plexiglas on the working area side.

Figure 36. Short-stay and moderate wards in a severe acute respiratory infection treatment centre

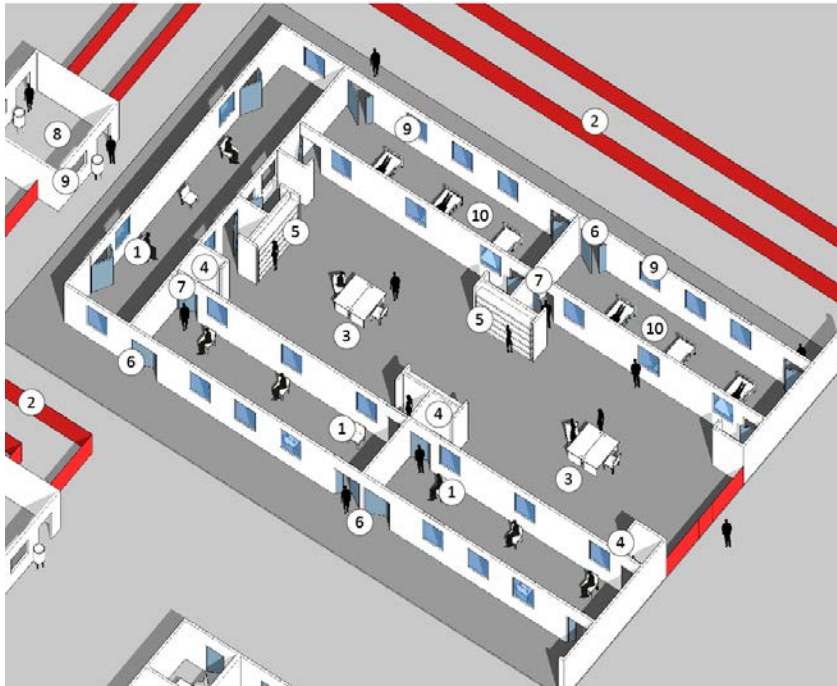

1. Patients. [at least 2 m distance]
2. Single fence [1.2 metre height] is to identify centre area. Double fence with 1 metre spacing can be used to help visitors respect the spatial distance while visiting patients [not mandatory].
3. Working area. [staffs only]
4. Doffing space
5. Shelf for PPE
6. Patient entrance
7. Staff entrance only
8. Discharge room
9. Open window to assure natural ventilation
10. Short stay observation. Bed with proper distance in between

Severe and critical wards, and intensive care units

Figure 37 demonstrates a severe ward, intensive care unit or moderate ward. Note that patients' rooms and short-stay wards must have a ceiling on the patient's side to ensure proper airflow.

Figure 37. Severe and critical wards, intensive care units and moderate wards in a severe acute respiratory infection treatment centre

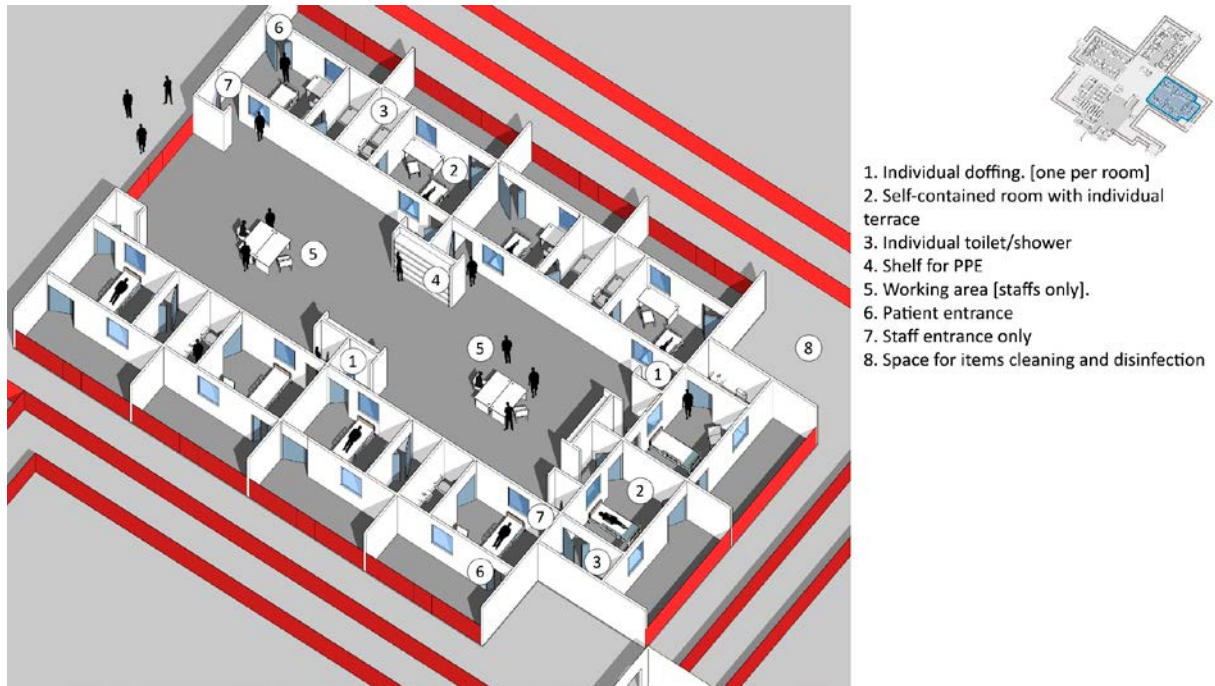

Use of transparent surfaces

The use of transparent surfaces or windows between the patients' rooms and the working area or nursing station (Figures 38 and 39) enables:

- visual contact with patients, strengthening the bedside relationship, the anthropological approach and community engagement;
- observation and monitoring, improving patient care through continuous patient observation and monitoring, and permitting a fast response;
- installation of an oxygen concentrator and ventilator, monitor and pulse oximeter in the working area rather than the patient's room, reducing the risk of nosocomial infections;
- reduced use of PPE, as many medical activities may be performed directly from the working area.

Figure 38. Use of transparent surface to allows observation and visual contact

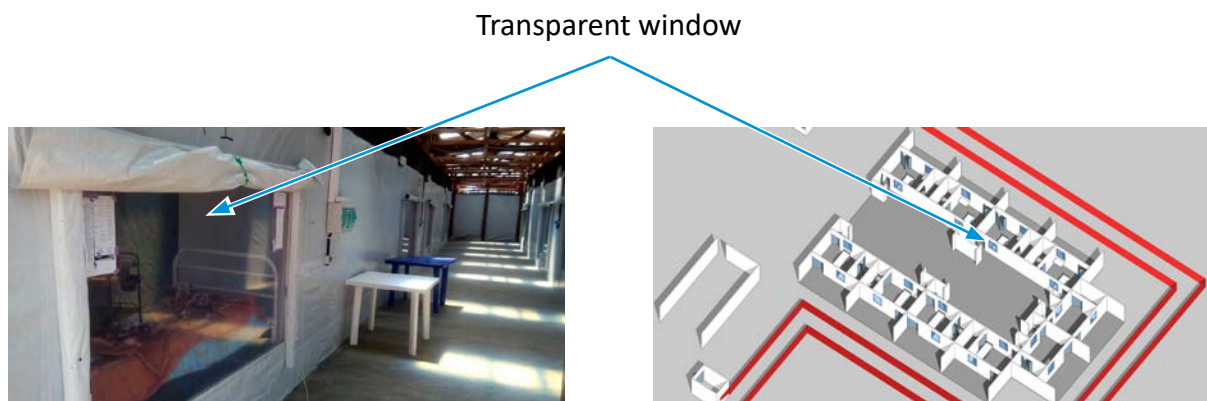

Source: Médecins Sans Frontières, 2018.

Figure 39. Example of transparent surface with oxygen concentrator and monitor installed outside patient's room



Source: Ian Crozier, MD (used with permission)

Establishing a SARI treatment centre in a tent

Figure 40 shows a global view of an example of a treatment centre.

Figure 40. Global view of an example of a severe acute respiratory infection treatment centre

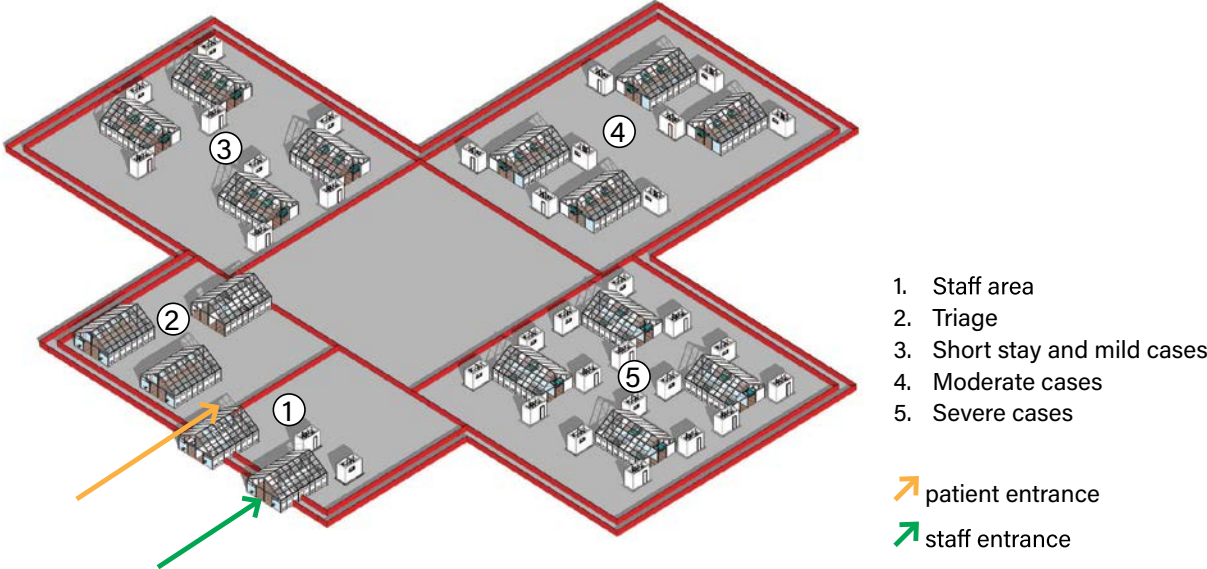

Figure 41 shows an example of a severe ward within a tent.

Figure 41. Example of severe ward within a tent at a severe acute respiratory infection treatment centre

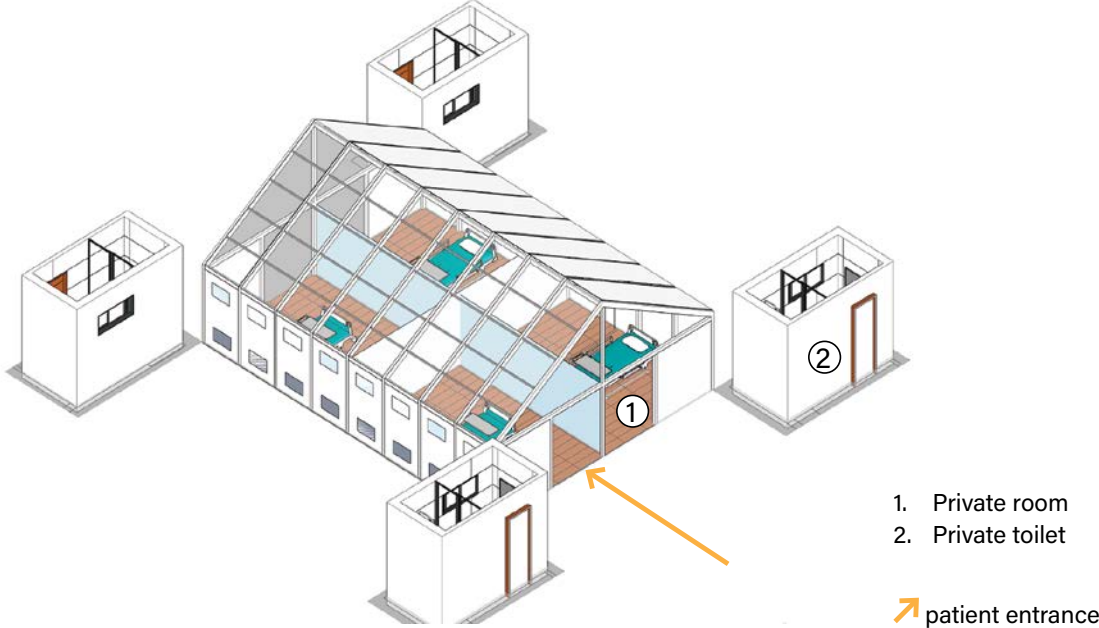

Figure 42 shows an example of a short-stay ward within a tent.

Figure 42. Example of short-stay ward within a tent at a severe acute respiratory infection treatment centre

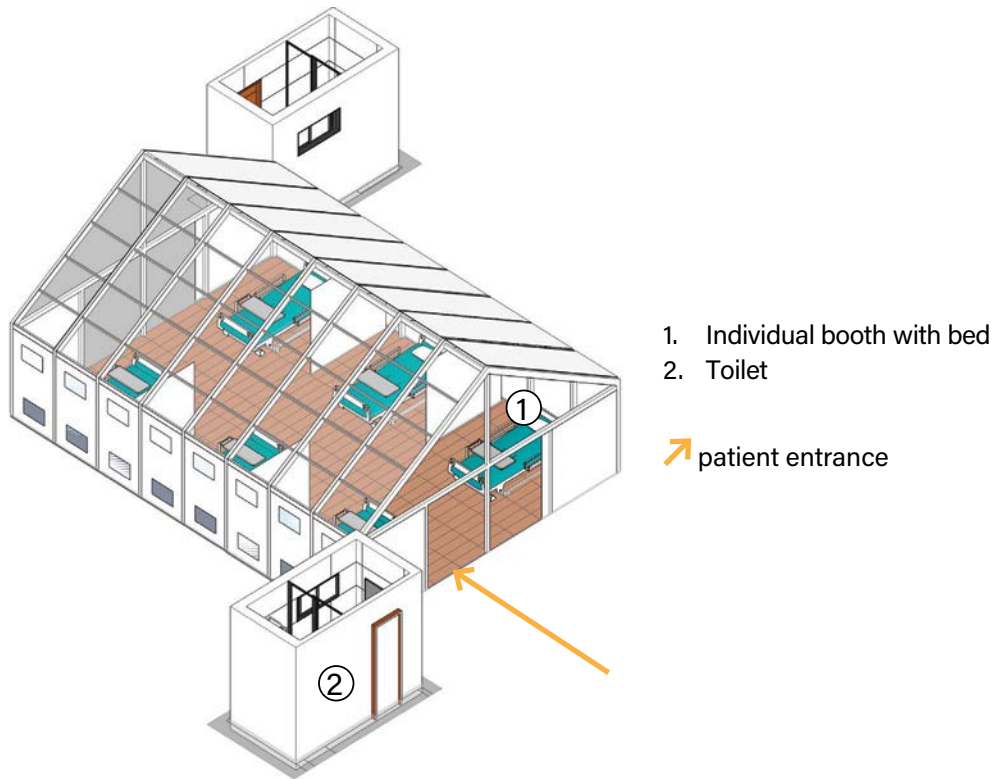
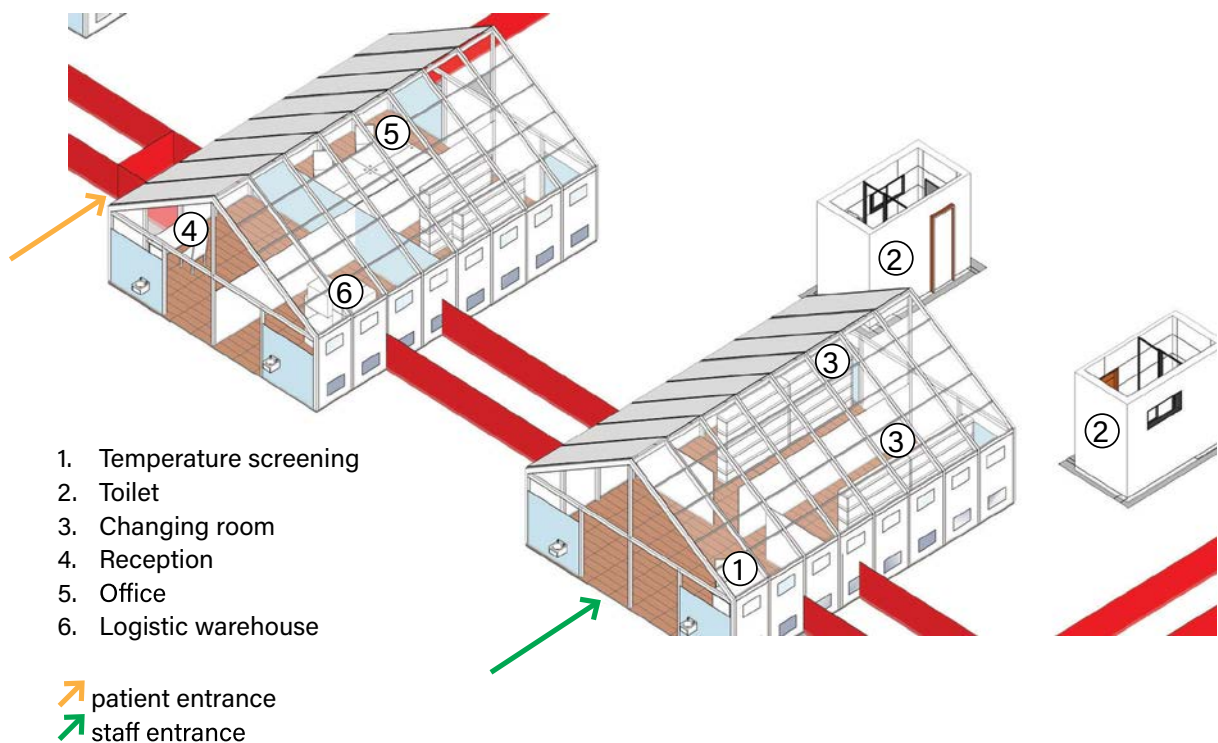

Figure 43 shows an example of a staff entrance within a tent.

Figure 43. Example of staff entrance within a tent at a severe acute respiratory infection treatment centre



Community facility

Where health facilities can no longer manage patients with mild or moderate disease, isolate patients who are not at high risk for severe disease (< 60 years of age, no co-morbid diseases) either in community facilities (e.g. stadium, gymnasium, hotel or tent etc.) (Figure 44) with access to rapid health advice (i.e. via adjacent dedicated COVID-19 health post, telemedicine) or at home according to WHO guidance³ and national or subnational capacity. If patient develops symptoms that may correspond to severe disease or complications, ensure rapid referral to hospital. Two metres distance between beds and male/female separation should always be ensured.⁴ Changing rooms and offices could be used for the medical post or other support activities.

Figure 44. Example of a basketball court repurposed into a community facility

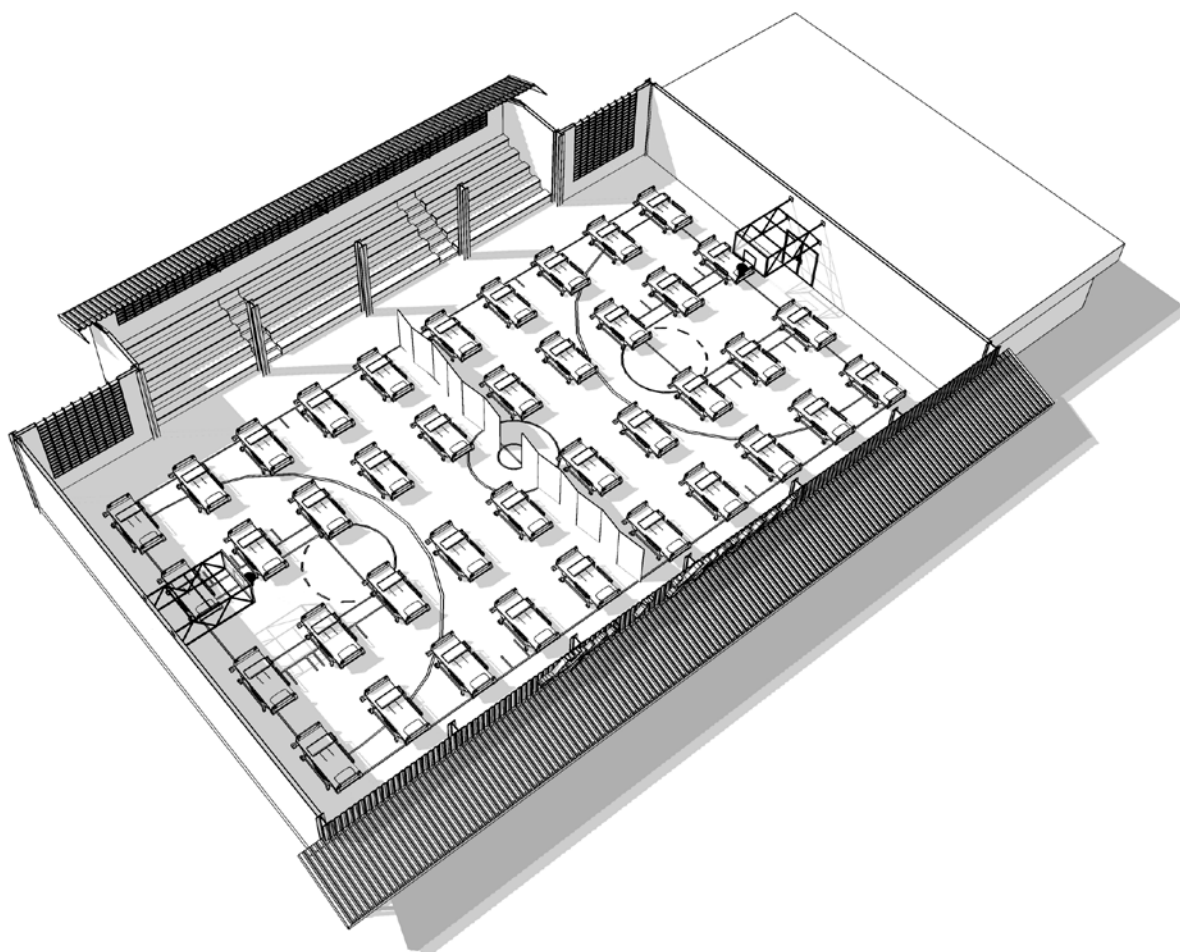

3 See: [https://www.who.int/publications-detail/home-care-for-patients-with-suspected-novel-coronavirus-\(ncov\)-infection-presenting-with-mild-symptoms-and-management-of-contacts](https://www.who.int/publications-detail/home-care-for-patients-with-suspected-novel-coronavirus-(ncov)-infection-presenting-with-mild-symptoms-and-management-of-contacts)

4 Recommended spatial distance for IPC is 1 metre. However, in order to facilitate access and movement of health-care workers, 2 metres separation is advised.

Surge capacity

Surge capacity, or the ability of a health system to meet an increased demand for health services, is a cornerstone of the overall approach to managing health emergencies. It has implications for the functioning of the entire system (28). The principles of surge capacity should be integrated into a health facility's preparedness and response capacities for all functions.

Surge capacity entails (28):

- human resource management, especially staffing;
- supplies, equipment, logistics and re-supply mechanisms;
- specific expertise for critical areas of care;
- overall management of hospital resources, such as expanding space and premises

Planning for surge capacity should allow for progressive scale-up of activities over several stages, with clearly defined activation thresholds for each stage (28).

A severe acute respiratory infection treatment centre flexibility and extension plan should be an integral part of surge capacities. Moving from a severity categorization to a cohorting approach enables to quickly respond to change in the transmission dynamics. For instance, when facing contained and defined clusters, the severity categorization could be used to better implement IPC measures. As soon as the dynamic turns into community transmission, the cohorting approach should be implemented to increase bed capacity. Patient cohorting means placing patients infected or colonized with the same laboratory-confirmed pathogens in the same designated ward (1), regardless of the availability of self-contained individual rooms but always considering the 2 m distance between patients⁵ and adapted ventilation and exhausted air treatment.

Figure 45 shows an example where the previously proposed setup with severity categorization is turned into a cohorting approach including two extensions for wards for confirmed cases.

⁵ Recommended spatial distance for IPC is 1 metre. However, in order to facilitate access and movement of health-care workers, 2 metres separation is advised.

Figure 45. Setup of a severe acute respiratory infection centre using a cohorting approach

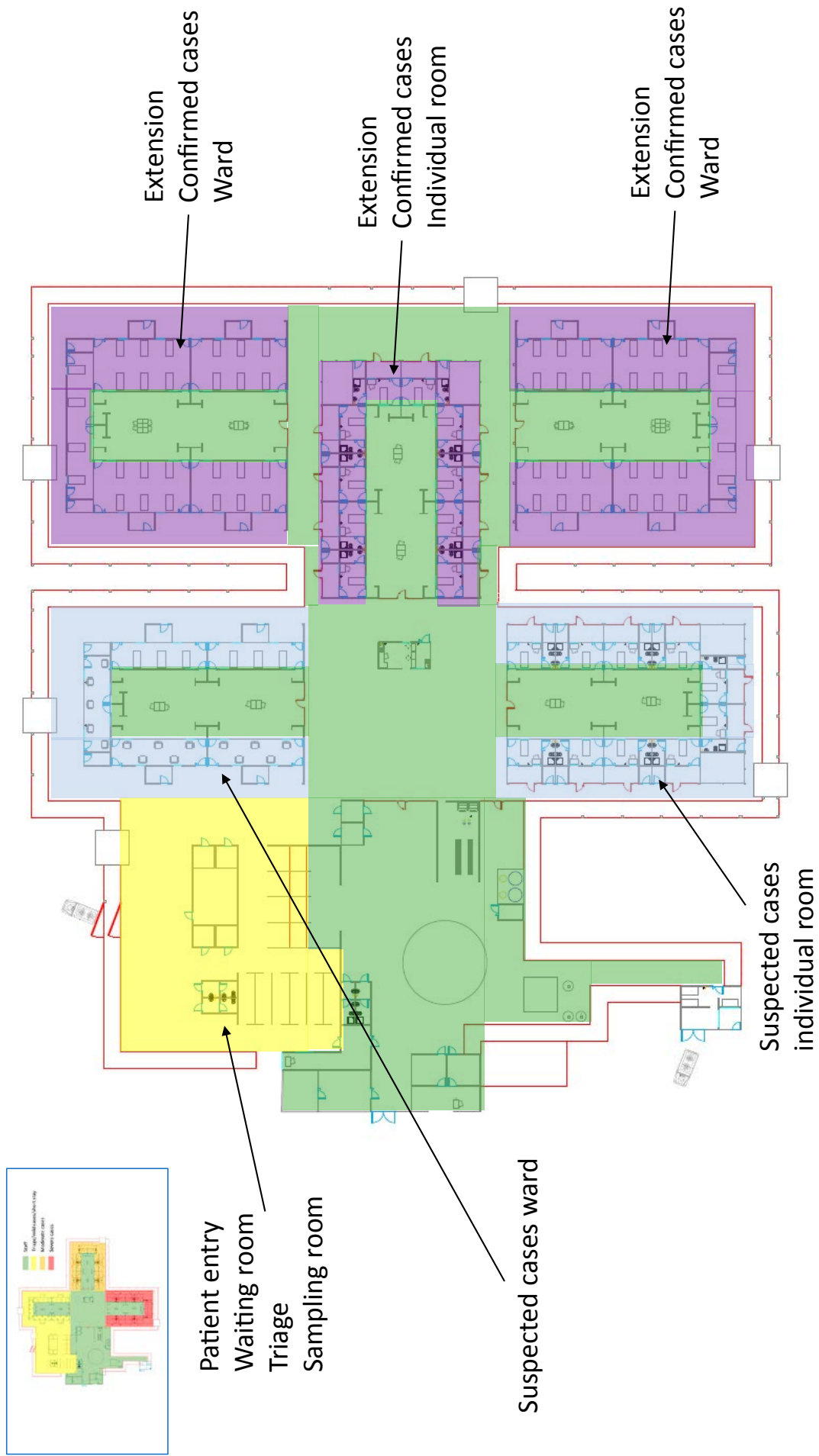

Implementation of infection prevention and control measures

To achieve the highest level of effectiveness in the response to a SARI outbreak such as the COVID-19 outbreak, using the strategies and practices recommended, an IPC programme with a dedicated and trained team or at least an IPC focal point should be in place and supported by the national and facility senior management (32). In countries where IPC is limited or inexistent, it is critical to start by ensuring that at least minimum requirements for IPC are in place as soon as possible, at both national and facility levels, and to gradually progress to the full achievement of all requirements of the IPC core components according to local priority plans (33).

Use of personal protective equipment

Precautions to be implemented by health-care workers caring for people with SARI include using PPE appropriately. This involves selecting the proper PPE and being trained in how to put on, remove and dispose of it. PPE is only one effective measure within a package that comprises administrative and environmental and engineering controls (1).

In order to rationalize the use of PPE, the strategies shown in Figure 46 should be implemented (6).

Figure 46. Strategies to optimize the availability of personal protective equipment (PPE)

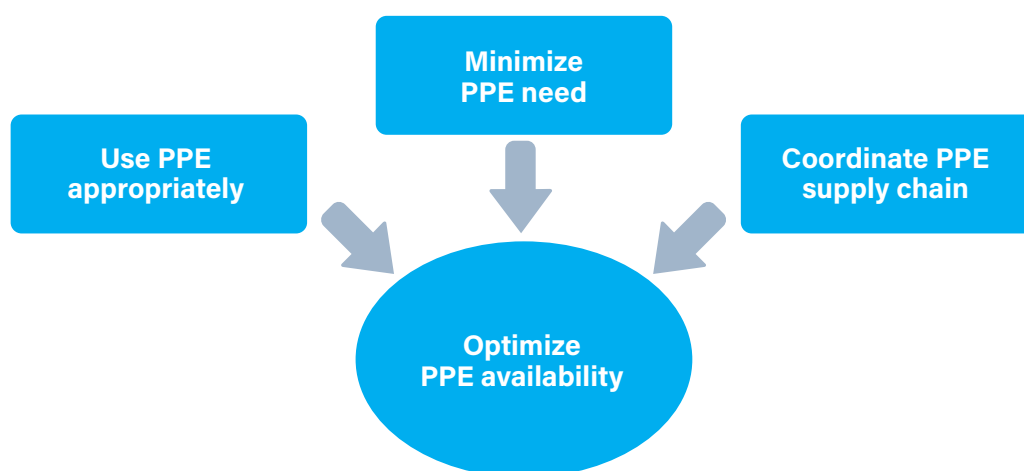

Source: Rational use of personal protective equipment for coronavirus disease 2019 (COVID-19). Geneva: World Health Organization; 2020.

The following interventions can minimize the need for PPE while protecting health-care workers and other people from exposure to the infection in health-care settings:

- Use physical barriers to reduce exposure to the virus, such as glass or plastic windows. This approach can be implemented in areas where patients first present, such as triage areas, the registration desk at the emergency department, or the pharmacy window where medication is collected.
- Restrict health-care workers from entering the rooms of patients with SARI if they are not involved in direct care. Consider bundling activities to minimize the number of times a room is entered (e.g. check vital signs during medication administration; have food delivered by health-care workers while they perform other care), and plan which activities will be performed at the bedside.

Ideally visitors should not be allowed. If this is not possible, restrict the number of visitors to areas where patients with SARI are being isolated; restrict the amount of time visitors are allowed to spend in the area; and provide clear instructions about how to put on and remove PPE and perform hand hygiene to ensure visitors avoid self-contamination (see Annex 9) (6).

PPE should be based on the risk of exposure (e.g. type of activity) and the transmission dynamics of the pathogen (e.g. contact, droplet, aerosol). The overuse of PPE has a further impact on supply shortages. Observing the following recommendations will ensure the use of PPE rationalized.

The type of PPE used when caring for people with COVID-19 will vary according to the setting, type of personnel and activity (Table 12). Health-care workers involved in the direct care of patients should use gowns, gloves, medical masks and eye protection (goggles, face shields).

For aerosol-generating procedures (e.g. tracheal intubation, non-invasive ventilation, tracheostomy, cardiopulmonary resuscitation, manual ventilation before intubation, bronchoscopy), health-care workers should use respirators (e.g. N95, FFP2), eye protection, gloves and gowns. Aprons should also be worn if gowns are not fluid-resistant (1).

Respirators (N95, FFP2 or equivalent standard) have been used for an extended time during previous public health emergencies involving acute respiratory illness when PPE was in short supply (3). This refers to wearing the same respirator while caring for multiple patients with the same diagnosis without removing the respirator. Evidence indicates that respirators maintain their protection when used for extended periods. Using the same respirator for more than four hours can lead to discomfort, however, and should be avoided (6).

Table 12. Recommended personal protective equipment (PPE) for use in the context of COVID-19, according to the setting, personnel and type of activity

Setting	Target staff or patient	Activity	Type of PPE or procedure
Health-care facilities			
Inpatient facilities			
Patient's room	Health-care workers	Providing direct care to patients with SARI	Medical mask, gown, gloves, eye protection (goggles or face shield)
		Aerosol-generating procedures performed on patients with SARI	Respirator N95 or FFP2 standard or equivalent, gown, gloves, eye protection, apron
	Cleaners	Entering patient's room	Medical mask, gown, heavy-duty gloves, eye protection (if risk of splash from organic material or chemicals), boots or closed work shoes
	Visitors	Entering patient's room	Medical mask, gown, gloves
Other areas of patient transit (e.g. wards, corridors)	All staff, including health-care workers	Any activity that does not involve contact with patients	No PPE required
Triage	Health-care workers	Any	Maintain distance of at least 2 m
	Patients with respiratory symptoms	Any	Provide medical mask if tolerated by patient
Laboratory	Laboratory technicians	Manipulation of respiratory samples	Medical mask, gown, gloves, eye protection (if risk of splash)
Administrative areas	All staff, including health-care workers	Administrative tasks that do not involve contact with patients	No PPE required

Outpatient facilities			
Consultation room	Health-care workers	Physical examination of patients with respiratory symptoms	Medical mask, gown, gloves, eye protection
	Health-care workers	Physical examination of patients without respiratory symptoms	PPE according to standard precautions and risk assessment
	Patients with respiratory symptoms	Any	Provide medical mask if tolerated
	Patients without respiratory symptoms	Any	Provide medical mask if tolerated
	Cleaners	After and between consultations with patients with respiratory symptoms	Medical mask, gown, heavy-duty gloves, eye protection (if risk of splash from organic material or chemicals), boots or closed work shoes
Waiting room	Patients with respiratory symptoms	Any	Provide medical mask if tolerated; immediately move patient to isolation room or separate area away from others; if this is not feasible, ensure distance of at least 2 m from other patients
	Patients without respiratory symptoms	Any	Provide medical mask if tolerated
Administrative areas	All staff, including health-care workers	Administrative tasks	No PPE required
Triage	Health-care workers	Preliminary screening not involving direct contact	Maintain distance of at least 1 m; no PPE required
	Patients with respiratory symptoms	Any	Maintain distance of at least 1 m; provide medical mask if tolerated
	Patients without respiratory symptoms	Any	No PPE required

SARI, severe acute respiratory infection.

¹ The number of visitors should be restricted. If visitors must enter a patient's room, they should be provided with clear instructions about how to put on and remove PPE and about performing hand hygiene before putting on and after removing PPE; this should be supervised by a health-care worker.

Surface cleaning and disinfection, materials and equipment for infection prevention and control at the facility level

A clean environment plays an important role in the prevention of hospital-acquired infections. Many factors, including the design and organization of the health-care facility, availability of and access to safe water, appropriate sanitation, laundry systems and air quality, can significantly influence the transmission of infection (32).

Cleaning staff

Appropriate staffing levels (number of staff) and capacity (training, education) are key programme elements (31). Cleaning roles should always be paid positions that have:

- written job descriptions or terms of reference;
- structured, targeted training (e.g. preservice, annual, when new equipment is introduced);
- defined performance standards or competencies;
- access to an on-site supervisor to ensure they can safely perform their work (e.g. address supply shortage, safety concerns).

According to best practices, cleaning staff should (31):

- be familiar with their job descriptions and performance standards;
- be asked to perform duties only for which they have been trained – for example, they should not be asked to clean high-risk wards unless they have received specific training for those areas;
- know the identities and hazards of the chemicals that they could be exposed to in the workplace;
- have supplies and equipment, including PPE, to perform their duties;
- have working shifts consistent with acceptable norms for the given context.

Cleaning supplies and equipment

The selection and appropriate use of supplies and equipment are critical for effective environmental cleaning. Table 13 lists the products available for environmental cleaning in health care, and their properties, advantages and disadvantages (31).

Table 13. Products for environmental cleaning

Ideal properties	<p>All products used for health-care environmental cleaning:</p> <ul style="list-style-type: none"> ▪ Nontoxic: it should not be irritating to the skin or mucous membranes of staff, visitors or patients; everything being equal, choose products with the lowest toxicity rating ▪ Easy to use: directions for preparation and use should be simple and contain information about required PPE ▪ Acceptable odour: it should not have offensive odours to users or patients ▪ Solubility: it should be easily soluble in warm and cold water ▪ Economical/low cost: it should be affordable
Additional properties	<p>Cleaning products:</p> <ul style="list-style-type: none"> ▪ Efficacious: it should remove dirt, soil and various organic substances ▪ Environmentally friendly: it should be biodegradable and not cause environmental pollution upon disposal <p>Disinfectants:</p> <ul style="list-style-type: none"> ▪ Broad spectrum: it should have a wide antimicrobial range, including pathogens that are common causes of hospital-acquired infections and outbreaks ▪ Rapid action: it should be fast-acting and have a short contact time ▪ Remains wet: it should keep surfaces wet for long enough to meet recommended contact times with a single application ▪ Not affected by environmental factors: it should be active in the presence of trace quantities of organic matter (e.g. blood) and compatible with cleaning supplies (e.g. cloths) and products (e.g. detergents) and other chemicals encountered in use ▪ Material compatibility: it should be proven compatible with common health-care surfaces and equipment ▪ Persistence: it should have residual antimicrobial effect on treated surfaces ▪ Cleaner: it should have some cleaning properties ▪ Non-flammable: it should have a flash point over 65 °C (150°F) ▪ Stability: it should be stable in concentration and use dilution

Cleaning products include liquid soap, enzymatic cleaners and detergents. They remove organic material (e.g. dirt, body fluids) and suspend grease or oil. This is done by combining the cleaning product with water and using mechanical action (i.e. scrubbing and friction). For most environmental cleaning procedures, select neutral detergents (pH 6–8) that are easily soluble in warm and cold water.

Some specialized cleaning products may provide advantages for specific areas or materials within the health-care facility, such as bathroom/toilet cleaners, floor polishers and glass cleaners. The use of specialized products should be considered on a case-by-case basis, however, weighing the advantages and disadvantages (e.g. additional cost) and ability of the facility to ensure the correct storage, preparation and use (31).

Disinfectants are only for disinfecting after cleaning and are not substitutes for cleaning, unless they are combined detergent–disinfectant products. Before disinfecting, use a cleaning product to remove all organic material and soil (31). Common low- and intermediate-level disinfectants that can be used for environmental surfaces in health-care settings include (31):

- quaternary ammonium compounds
- alcohol (ethyl or isopropyl)
- chlorine-releasing agents (e.g. bleach, sodium or calcium hypochlorite)
- improved hydrogen peroxide.

For a detailed list of disinfectants, see *Disinfectants for use against the Ebola virus* (34) and *Products with Emerging Viral Pathogens AND Human Coronavirus claims for use against SARS-CoV-2* (35).

Environmental cleaning services area

There should be at least one designated environmental cleaning services area within each ward and area for preparation, storage and reprocessing of reusable cleaning equipment and supplies. This area should be a dedicated space that is not used for any other purposes. A separated area should be available for biomedical equipment reprocessing.

The designated environmental cleaning services area should:

- be well ventilated and illuminated (lighting or window access);
- be labelled with a biohazard sign on the door;
- have an appropriate water supply (hot and cold water access, if feasible);
- have a utility sink or floor drain for safe disposal of used solutions;
- be designed so that, whenever possible, buckets can be emptied into a utility sink or floor drains without lifting or creating splashes;
- have a dedicated handwashing sink, used only for handwashing;
- have access to an eyewash station;
- have appropriate PPE available;
- have enough space to keep reprocessing (dirty areas) separate from storage areas for cleaned equipment;
- be easily accessible in relation to the areas it serves (easily accessible throughout the facility);
- be appropriately sized to the amount of materials, equipment and chemicals stored in the room or area;
- have printed copies of the safety datasheets and manufacturers' instructions for all environmental cleaning products;
- never contain personal clothing or grooming supplies, food or beverages (there should be a separate area for cleaning staff to store these items);
- have safe chemical storage and access;
- have locks fitted to all doors to restrict access only to cleaning staff;
- be free from clutter to facilitate cleaning;
- have washable surfaces (floors, walls, shelves).

General environmental cleaning techniques

For all environmental cleaning procedures, always use the following general strategies:

Conduct visual preliminary site assessment

Proceed only after a visual preliminary site assessment to determine whether:

- there is any need for additional PPE or supplies (e.g. spills of blood/body fluids, or the patient's status could pose a challenge to safe cleaning, or the patient is on transmission-based precautions);
- there are any obstacles (e.g. clutter) or issues that could pose a challenge to safe cleaning;
- there is any damaged or broken furniture or surfaces to be reported to the supervisor or management.

Proceed from cleaner to dirtier

Proceed from cleaner to dirtier areas to avoid spreading dirt and microorganisms. Practical examples of this strategy include the following:

- During terminal cleaning, clean low-touch surfaces before high-touch surfaces.
- Clean patients' areas before patients' toilets.
- Within a specified patient's room, terminal cleaning should start with shared equipment and common surfaces. Then proceed to surfaces and items touched during patient care that are outside the patient zone. Finish with surfaces and items directly touched by the patient inside the patient zone. In other words, high-touch surfaces outside the patient zone should be cleaned before the high-touch surfaces inside the patient zone.
- Clean general patient areas not under transmission-based precautions before areas under transmission-based precautions.

Proceed from high to low (top to bottom)

Proceed from high to low (top to bottom) to prevent dirt and microorganisms from dripping or falling down and contaminating already cleaned areas. Practical examples of this strategy include:

- cleaning bed rails before bed legs;
- cleaning environmental surfaces before cleaning floors;
- cleaning floors last to allow collection of dirt and microorganisms that may have fallen.

Proceed in a methodical, systematic manner

Proceed in a methodical, systematic manner to avoid missing areas. For example, proceed from left to right or clockwise (Figure 47). In a multi-bed area, clean each patient zone in the same manner – for example, start at the foot of the bed and move clockwise.

Figure 47. Example of a cleaning strategy for environmental surfaces, moving in a systematic manner around the patient care area

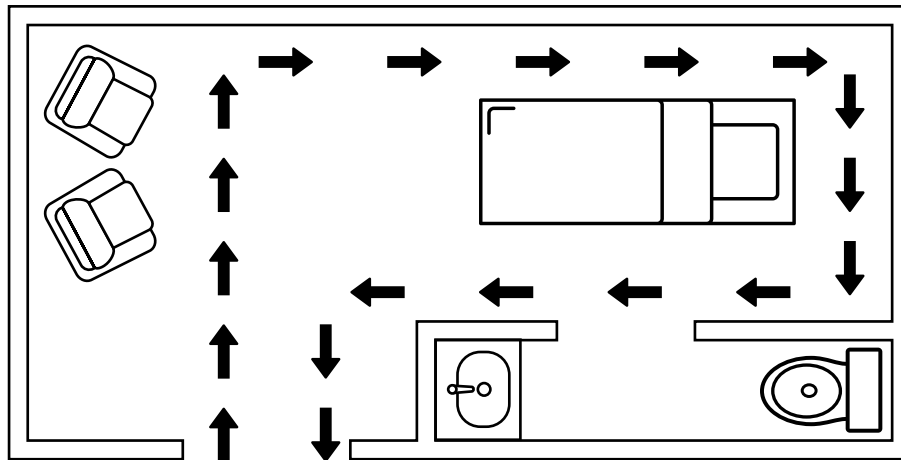

Environmental surface cleaning and disinfection

The environment must be thoroughly cleaned by applying the following general principles (32):

- Cleaning consists of the removal of dust, soil and contaminants on environmental surfaces and ensures a dry, hygienic and healthy health-care facility environment for patients, staff and visitors.
- Cleaning is an essential step before any disinfection process, as it removes dirt, debris and other materials that decrease the effectiveness of chemical disinfectants.
- The use of neutral detergent solutions is essential for effective cleaning.
- Special attention should be given to sanitation and toilet facilities as these are often areas that are heavily contaminated and reservoirs for hospital-acquired infections.
- Do not immerse electromechanical biomedical equipment in water: when cleaning the floor, be sure that equipment is disconnected.
- Routine bacteriological monitoring to assess the effectiveness of environmental cleaning is not required.

Large-surface cleaning methods should be avoided because they produce mists or aerosols or disperse dust in patient care areas (e.g. dry sweeping, spraying, dusting) (32).

Laundry and surfaces in all environments in which people with COVID-19 receive care (treatment units, community care centres) should be cleaned regularly (at least once a day and when a patient is discharged). There are many disinfectants active against enveloped viruses, such as nCoV, including commonly used hospital disinfectants. Currently, WHO recommends the use of (36):

- 70% ethyl alcohol to disinfect small areas such as reusable dedicated equipment (e.g. thermometers) between uses;
- sodium hypochlorite at 0.5% (5000 ppm) for disinfection of surfaces.

Linen management

All staff dealing with soiled bedding, towels and clothes from patients with COVID-19 should wear appropriate PPE, including heavy-duty gloves, masks, eye protection (goggles or face shield), long-sleeved gowns, aprons (if gowns are not fluid-resistant), and boots or closed shoes, before touching any soiled linen. They should perform hand hygiene after exposure to blood and body fluids and after PPE removal.

Soiled linen should be placed in clearly labelled leak-proof bags or containers after carefully removing any solid excrement, which should be put in a covered bucket before disposal in the toilet or latrine.

Machine washing with warm water (60–90 °C) and laundry detergent is recommended.

If machine washing is not possible, linens can be soaked in hot water and soap in a large drum, using a stick to stir, avoiding splashing. The drum should then be emptied and the linen soaked in 0.05% chlorine for about 30 minutes. Finally, the linen should be rinsed with clean water and dried fully in sunlight.

For more information related to water, sanitation, hygiene and waste management, see Water, Sanitation, Hygiene and Waste Management for COVID-19 (36).

Cleaning and disinfection of biomedical devices

Sterilization or decontamination of items, equipment and medical devices is a complex and highly specialized subject. All patient care surfaces, medical devices and equipment used in health care have the potential to become contaminated with microorganisms. Once contaminated, these items can pose a risk to patients, staff and visitors. As an essential component of IPC strategies, all health-care facilities should implement a standardized operating procedure for the safe and effective decontamination of high-touch patient care areas and all reusable items and equipment to prevent cross-infection. It is essential that facilities have a dedicated area for the decontamination of reusable items and equipment (32).

The WHO manual Decontamination and Reprocessing of Medical Devices for Health-care Facilities (37) outlines the decontamination lifecycle, including specific cleaning, disinfection and sterilization methods applied to medical devices. Always follow the device manufacturer's instructions for decontamination so as to not cause any damage and ensure proper decontamination.

It is essential that facilities have a dedicated area for the decontamination of reusable biomedical devices (32). Different devices require different treatment according to their design (e.g. sharp corners, serrated edges, coils), the feasibility of disassembly, and their location inside the health facility (low-, medium- or high-risk contaminated area).

The cleaning procedure needs to ensure that no cross-contamination of different components cleaned in the same clean line happens. It is also important to avoid electrical, mechanical, thermal and chemical damage. The two generic flows of the decontamination cycle for reusable devices are:

Collection → Cleaning → Disinfection → Drying → Storage

Collection → Cleaning → Disinfection → Drying → Sterilization → Storage

It is important to notice that if the reusable device requires sterilization, it must still pass through the previous steps.

For more information see Decontamination and Reprocessing of Medical Devices for Health-care Facilities (37).

Equipment should not be transported until it has been decontaminated. Note that commonly used disinfectants are effective against 2019-nCoV. In general, minimize the exposure of medical equipment by removing any unessential equipment from the patient's area and by protecting as much as possible the components not in contact with the patient. Always apply policies for proper hand hygiene.

Management of dead bodies

The burial and cremation processes are a sensitive time for the family and the community and can be the source of trouble or even open conflict. Before starting any procedure, the family must be fully informed about the process and their religious and personal rights to show respect for the deceased. Ensure the formal agreement of the family has been given before starting the burial. No burial should begin until family agreement has been obtained (38).

Until more is known about how 2019-nCoV spreads, it is recommended to use a combination of standard, contact and droplet precautions to protect health-care workers managing the body of a person with suspected or confirmed COVID-19 (39).

The responsible authority within the treatment centre should organize and prepare a team for dead body management. This team should have received appropriate training. They should have the necessary materials and PPE to prepare the body for burial.

The body should be packed in a specific body bag (40) with absorbent pads and the patient's identification marked on it. Before entering the room, the team should have confirmation of death and the patient information from the medical team. The medical team should have already removed any sharps and biomedical devices and covered the body with a sheet. The patient's identifying information should be written on the body bag in permanent marker to ensure the body is correctly identified via identification number and name.⁶ If a swab is required at death, ensure the sample has already been taken.

The body bag procurement specifications are as follows (41):

- full-length U- or J-shaped zipper, with large metal loops on the zip-runner;
- leak-proof during handling and transportation of the body;
- highly tear-proof and puncture-resistant;
- heat-sealed seams, with a seal width not less than 10 mm;
- linear enforced polyethylene (PE), ethylene-vinyl acetate (EVA) or poly(ethylene-vinyl acetate) (PEVA);
- thickness of 300–400 µm;
- no chlorides (cremation);
- nondegradable (bag disintegrates in soil in 5–8 years);
- carrying capacity of 120 kg (adult) or 50 kg (child);
- four to six integrated reinforced carrying handles;
- white colour;
- size 220 × 100 cm (adult) or 120 × 80 cm (child);
- integrated transparent label pocket for identification tag (optional).

In order to avoid risk of aerosol production, do not spray the body with chlorine or other disinfectant products. If it is more than 24 hours since the person died, or if burial/cremation is not foreseen within the next 24–48 hours, use a second body bag.

⁶ For more information see: <https://www.who.int/emergencies/diseases/novel-coronavirus-2019/technical-guidance>.

Laboratory equipment and consumables

The recommended sources of information concerning the laboratory testing and biosafety guidance to be followed for 2019-nCoV are:

- Laboratory Biosafety Guidance Related to the Novel Coronavirus (2019-nCoV) (42)
- Laboratory Testing for 2019 Novel Coronavirus (2019-nCoV) in Suspected Human Cases (43).

These documents function as a guide and are changing regularly as we learn more about the virus and its epidemiology. It is highly recommended that they are consulted at regular intervals.

At the time of publication, the choice of laboratory diagnosis is limited to validated nucleic acid amplification protocols. As such, the choice of thermocycler and complementary consumables, in addition to reagents, is restricted to the choices given in the selected protocol to be used and followed.

A general nucleic acid amplification test (real-time reverse-transcriptase polymerase chain reaction (PCR)) require the following essential components:

- primers and probes
- real-time reverse-transcriptase PCR reagent kit
- optical reaction reservoir in tube, strip-tube or plate format
- nucleic acid extraction kit.

Complementary material may include:

- biological safety cabinet class II
- vortex mixer
- microcentrifuge
- micropipettes and aerosol barrier tips (P2, P20, P200, P1000)
- disposable powder-free gloves
- RNase surface decontamination solution
- appropriate PPE.

Water supply

The main objective is to have large quantities of safe water easily accessible at all times. A reliable water supply is crucial, from source to distribution points. If no water supply system is available, anticipate water trucking, including installation of storage and distribution systems (44).

All equipment in contact with water or chlorine solutions must be made of plastic to avoid damage. All containers, pipes and taps should be clearly labelled or colour-coded to avoid confusion between clean water and chlorine solution (e.g. blue for clean water, red for chlorine solution).

Water is required for the following care and IPC procedures:

- drinking water and preparation of oral rehydration salts
- handwashing (with soap and water or chlorine solution)
- cleaning (e.g. floor, surfaces, fomites, buckets, utensils)
- decontamination of materials, beds, buildings and surfaces
- decontamination of reusable PPE
- cleaning showers and toilets
- laundry
- food preparation
- fire safety.

Water quality

A number of measures can be taken to improve water safety, starting with source water protection, treatment of water (at point of distribution, collection or consumption), and safe storage of treated water in regularly cleaned and covered containers at home. Furthermore, conventional, centralized water treatment methods that utilize filtration and disinfection should inactivate COVID-19 virus. Other human coronaviruses have been shown to be sensitive to chlorination and UV disinfection (36). Factors for water quality include turbidity, free residual chlorine concentration, toxic compounds, and acceptance. For more information, see The Sphere Handbook: Humanitarian Charter and Minimum Standards in Humanitarian Response (45).

SARI treatment centres should be able to test and monitor the quality and safety of their treated water, and this includes the ability to analyse the raw water in order to optimize water treatment. For example, if turbidity is over five nephelometric turbidity units, change the source or pretreat. In cases of doubt, where possible use rapid tests or laboratory analysis for chemical compounds. If changes appear after preparation of chlorine solutions (e.g. colour, smell), perform analysis. Ensure systematic disinfection by proper chlorination of all water supplied with monitoring. For more information, see Essential Environmental Health Standards in Health Care (44).

For effective centralized disinfection, there should be a residual concentration of free chlorine of at least 0.5 mg/l after at least 30 minutes of contact time at a pH below 8.016. A chlorine residual should be maintained throughout the distribution system.

If centralized treatment and safe piped water supplies are not available, a number of household water treatment technologies are effective in removing or destroying viruses, including boiling, high-performing ultra- and nano-membrane filters, solar irradiation, and (in non-turbid waters) UV irradiation and appropriately dosed free chlorine (36).

Water quantity

Large quantities of water are required for cleaning, decontamination procedures, laundry, drinking and hygiene. Water consumption depends more on the number of staff and size of the centre than on the number of patients.

The following are recommended daily estimate tools for a SARI treatment centre based on previous field experiences and available reference extrapolations (46):

- 250 litres/staff member⁷/day + 2 days backup
- 100–200 litres/bed capacity/day + 2 days backup.⁸

Aim for the higher values first and readjust if needed.

Waste zone

Consider the area as a normal health-care facility waste zone. There should be a cleaning and disinfection point, temporary waste storage, organic pit, sharp pit and incinerator with ash pit. For more information see *Water, sanitation, hygiene and waste management for COVID-19 (36)* and *Safe management of wastes from health-care activities (47)*.

If laboratory facilities are present in the centre, it is important to assess what kinds of waste may be produced and to consider installing a high-temperature incinerator that can reach 1200 °C and 2 second smoke-retention time or to assess the availability of cement kilns in the area.

Wastewater and faecal waste

All wastewater from patients' showers, sinks, handwashing points and laundry should be treated properly before infiltration. As part of an integrated public health policy, wastewater carried in sewerage systems should be treated in well-designed, well-managed, centralized wastewater treatment works. Each stage of treatment (as well as retention time and dilution) results in further reduction of potential risk. Waste-stabilization ponds (oxidation ponds or lagoons) are generally considered to be a practical and simple wastewater treatment technology that is particularly well-suited to the destruction of pathogens, as relatively long retention times (20 days or more) combined with sunlight, elevated pH levels, biological activity and other factors serve to accelerate pathogen destruction. A final disinfection step may be considered if existing wastewater treatment plants are not optimized to remove viruses. Best practices for protecting the occupational health of workers at sanitation treatment facilities should be followed. Workers should wear appropriate PPE (protective outerwear, gloves, boots, goggles or face shields, masks), perform frequent hand hygiene, and avoid touching the eyes, nose and mouth with unwashed hands (36).

Treatment for wastewater should include a well-sized grease trap (Figure 48) that is properly maintained, followed by an infiltration trench sized according to the ground characteristics (36,46).

Excreta management

Safe sanitation is essential for health, prevents infections, and improves and maintains mental and social well-being. Safe excreta management is based on the key principle that the products generated from the toilets are retained within the containment technology and discharged to the local environment in a manner that does not expose anyone to hazards (48).

A person with suspected or confirmed COVID-19 should be provided with a separate flushing toilet or latrine with a door separating the area from the patient's room. Flushing toilets should be properly operating with functioning drain traps. When possible, flushing should occur with the lid down to prevent droplet splatter and aerosol clouds.

If separate toilets are not possible, the toilet should be cleaned and disinfected at least twice a day by a trained cleaner wearing PPE (gown, gloves, boots, mask, face shield/goggles). Consistent with existing guidance, staff and health-care workers should have toilet facilities that are separate from all patients.

For smaller health-care facilities in low-resource settings, if space and local conditions allow, pit latrines may be the preferred option. Standard precautions should be taken to prevent contamination of the

⁷ Total number of hired staff working in the SARI treatment centre, including administrative, logistic, cleaning and health-care workers.

⁸ Consumption will be much greater if based on the number of staff per day.

environment by excreta. These precautions include ensuring at least 1.5 m between the bottom of the pit and the groundwater table (more in coarse sands, gravels and fissured formations), and ensuring the latrines are located at least 30 m horizontally from any groundwater source (including shallow wells and boreholes) (32).

If there is a high groundwater table or lack of space to dig pits, excreta (faeces and urine) should be retained in impermeable storage containers and left as long as is feasibly possible to allow for reduction in virus levels before moving off site for additional treatment or safe disposal. A two-tank system with parallel tanks facilitates inactivation by maximizing retention times: one tank can be used until full and then allowed to sit while the next tank is being filled.

Figure 48. Grease trap technical drawing

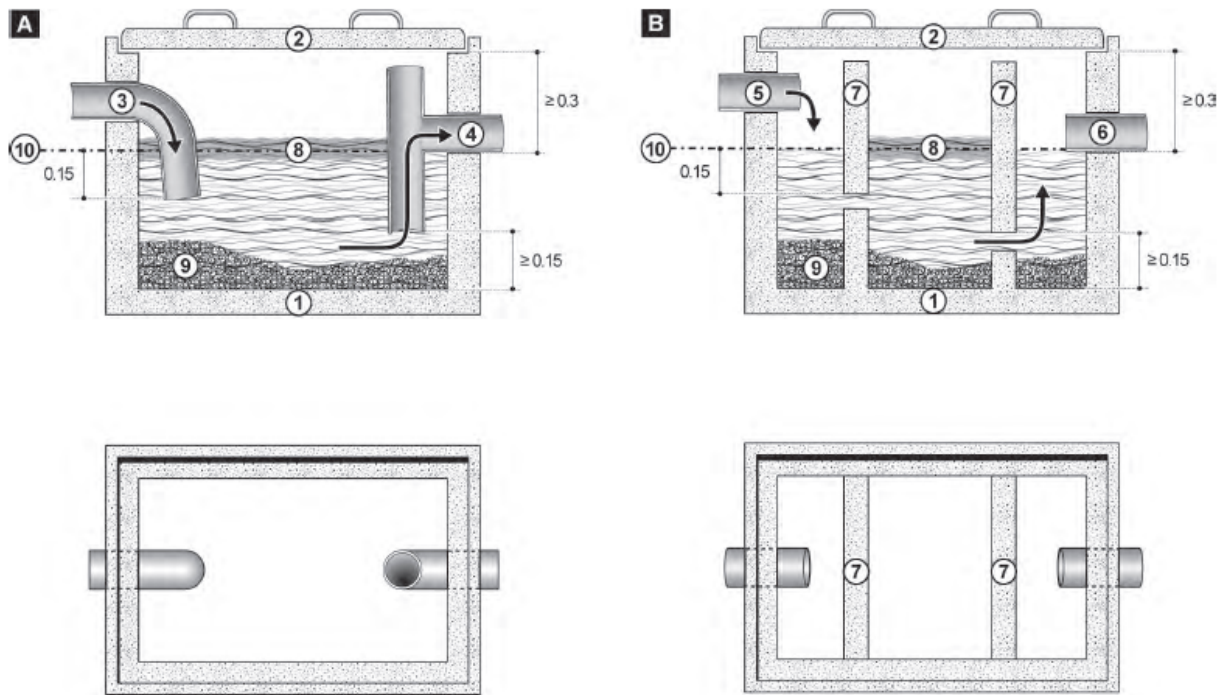

Key

Input

A. Model with elbow and tee

B. Model with baffles

- 1. Watertight casing
- 2. Removable lid with handles (each element < 50 kg)
- 3. Inlet elbow, 90°
- 4. Outlet tee
- 5. Inlet
- 6. Outlet
- 7. Separating partitions (baffles)
- 8. Middle zone (separation of fat, grease and oil)
- 9. Settled solids
- 10. Reference line indicating effective depth

- Detailed construction plans
- Fired bricks or cement blocks/concrete
- Cement, sand, (gravel), clean water
- Shuttering timber
- Reinforcing bars (6–8 mm)
- Shovel, hoe, pick and miner's bar
- Masonry tools
- Minimum 100 mm PVC pipe, or elbow and Tee
- Cover (e.g. concrete, metal, solid plastic) (max. water level)
- Temporary fence material

Measurements are indicated in m

Source: Public health engineering in precarious situations. Geneva: Médecins sans Frontières; 2010

Particular care should be taken to avoid splashing and release of droplets during use, cleaning or emptying of the toilet (36).

After collection and disposal of excreta from a bedpan, the bedpan should be cleaned with a neutral detergent and water, disinfected with a 0.5% chlorine solution, and rinsed with clean water (disposing of the rinse water in a drain, toilet or latrine). Other effective disinfectants include commercially available quaternary ammonium compounds such as cetylpyridinium chloride used according to the manufacturer's instructions, and peracetic or peroxyacetic acid at a concentration of 500–2000 mg/l (36).

Chlorine is an ineffective means to disinfect media containing large amounts of solid and dissolved organic matter. Therefore, there is limited benefit to adding chlorine solution to fresh excreta, and it may introduce risks associated with splashing (36).

For waste from people with suspected or confirmed COVID-19, there is no reason to empty latrines and holding tanks unless they are at capacity. In general, best practices of safely managing excreta should be followed.

Latrines or holding tanks should be designed to meet patient demand, considering potential sudden increases in numbers of cases. There should be a regular emptying schedule based on generated wastewater volumes. Appropriate PPE (long-sleeved gown, gloves, boots, masks, goggles/face shield) should be worn at all times when handling or transporting excreta, and great care should be taken to avoid splashing. For crews, this includes pumping out tanks or unloading pumper trucks. After handling, and once there is no risk of further exposure, individuals should safely remove PPE and perform hand hygiene before entering the transport vehicle.

Where there is no off-site treatment, in situ treatment can be done using lime. This includes using 10% lime slurry added at a ratio of 1 part of 10% lime slurry to 10 parts of waste (36).

Energy

For the electrical installations of a SARI centre, the following fundamental priorities must be kept in mind:

- safety of individuals (protection against electrocution and fire);
- protection of devices (protection against fire, power instability and effects of lightning);
- service continuity (protection against service breakdown, failure of power sources or any other interruption);
- cost control and environmental care (aspects that lead to the most accurate choice and sizing of power sources and control of the power demand).

Technical interventions on electrical systems should be performed only by certified electricians.

To ensure the reliability of electrical equipment, only equipment referring at least to International Electrotechnical Commission (IEC) certification should be purchased and installed.

For the design of installations:

- use equipment with internationally recognized terms and symbols;
- purchase only internationally certified electrical equipment;
- follow internationally authorized recommendations.

Everything compulsory or forbidden under the authority of local national regulations must be applied, even if not compliant to internal regulations or recommendations. Before installing any electrical appliance, always read the specifications mentioned on the identification plate or in the user manual and check whether it is fully compliant with the local standard.

Electrical standard

Electrical panel

The electrical panel is a safety and distribution device located upstream of the entire installation and all electrical circuits. It is considered to be the “brain” of any installation. Each area of a SARI centre must be equipped with its own electrical panel. The size of the panel depends on the power need by area and surface.

Components of the electrical panel include:

- electricity meter (if necessary)
- general circuit breaker
- distribution table for different circuits with differential disjuncture.

The electrical installation must comply with the standard of electricity.

Ensure each circuit is wired and protected according to the power delivered. In addition, a circuit must be dedicated to a single application – for example, the lighting, 10–16 A sockets, washing machines and air conditioners are each the subject of a separate circuit.

The circuit dedicated to 10–16 A sockets must not have more than eight distribution points. The lighting circuit must not exceed eight applications.

During installation, space (20%) must be left on the electrical panel for future equipment installation.

The size of the electrical panel depends on the surface of the building to be electrified and the number of modules to be integrated in the electrical box:

- An area of less than 35 m² requires at least two rows.
- An area of 35–100 m² requires at least three rows.
- An area above 100 m² requires a minimum of four rows.

Plugs

All fixed equipment must be fitted with electrical plugs complying with the local standard.

Junctions

Junctions must not be made outside protective enclosures. Junctions made by twisting wires together (with or without insulating tape) are forbidden. Junction boxes ideally should be constructed from insulating material (PVC or PE).

Cable protection

When using tubes and pipes for electrical conduits:

- the minimum diameter of a round pipe used as an electrical channel is 2 cm;
- the minimum diameter of a round pipe used as an electrical channel should be at least twice the diameter of the wires or the cable passing through; the distance between the hose clips fixing straight smooth PVC tubes should not exceed 60 cm.

Underground cables must be inserted into a flexible tube or PVC pipe. PVC pipes allow the placement of several cables inside the same pipe and facilitate the addition or replacement of cables:

- When several cables are placed in the same trench, the horizontal distance between cables should be 3–5 cm.
- Do not over-tension buried cables. It is better that some slack remains in the cable to resist possible small-scale land movements.
- The correct depth for a trench is 80 cm and the correct depth for a cable is 60 cm.
- Warning tape (Figure 49) should be placed at a depth of 15–20 cm below the surface of the ground.
- A maintenance hole must be placed at the site of each curve or junction.
- On straight ways a maintenance hole must be placed at least every 25 m.
- All sections between maintenance holes must be straight.
- Maintenance holes should be made with special PVC boxes, bricks or concrete and be protected against the rain.

Figure 49. Tape warning of buried electrical cable



Exiting of buried cables

Electrical cables must be properly mechanically protected as they exit the ground. Cables that exit vertically must be beside a wall or fixed structure. Vertical cables against a wall must be protected against shocks when installed outdoors. In such situations, cables must be protected by a thick steel pipe up to a height of 150 cm. The top of the pipe should be fitted with an elbow to prevent rainwater from entering (Figure 50).

Figure 50. Pipe arrangement for an electrical cable exiting the ground

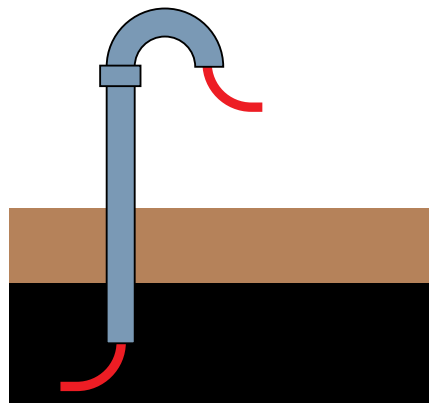

Other enclosures

It is preferable that electrical boards are manufactured from nonconductive materials such as polycarbonate, polyester or PVC. Closing systems (doors and covers), hinges and gaskets must be effective and in good condition. Electrical boards in dry areas must be at least IP44. Electrical boards placed outdoors or in technical areas must be at least IP66.

Earth connection

The earth connection is a device that makes it possible to channel a fault current towards the earth and automatically cut the electrical installation to ensure safety. Each building of a SARI centre must be equipped with a ground earth component comprising the following:

- ground connection consisting of a stake accessible by a maintenance hole;
- earth conductor (in an insulating conduit) or main earth pipe connecting the earth connection to the measuring or earthing bar (main earth terminal). This bar provides the connection between the earth conductor and the main protective conductor and makes it possible to measure the earth resistance;
- protective conductors;
- equipotential links.

When the earth connection is made with one or more earth stakes, the stakes are driven below the permanent humidity level at a depth of at least 2 m to limit the increase in resistance of the earth in case of frost or dryness (Figure 51).

The resistance of the earth electrode depends on its dimensions, its shape, and the resistivity of the terrain (which varies between terrains and with depth). The resistivity of the ground depends on the humidity rate and temperature. The humidity rate depends on the granulation and porosity of the soil. The resistivity of the ground increases when the humidity decreases. Frost and drought both increase the resistivity of the ground. In case of risk of frost or drought, the length of the stakes is increased by 1–2 m:

The resistance can be improved by connecting several stakes in parallel, spaced at a distance at least equal to their length. Several stakes can be installed to lower the earth resistance. In the case of multiple earth connections, it is necessary to connect them to each other using a section conductor of 16 mm² in insulated copper.

The ground earth rod component comprises the following:

- galvanized steel tubes at least 25 mm in diameter;
- galvanized mild steel side profiles at least 60 mm;
- copper or steel bars (steel bars are coated with copper or galvanized) 15 mm or less in diameter.

The connection must be accessible and protected against corrosion. The connection between an earth conductor and an earth connection must be made by a pressure connector or another fixing. Non-exothermic welding does not provide adequate mechanical strength.

The cross-section of the earth conductor must be:

- 16 mm² of copper or galvanized steel protected against corrosion;
- 25 mm² of copper or 50 mm² of galvanized steel not protected against corrosion.

The connection of the earth conductor to the earth must be accessible. Metal pipes for the distribution of liquids or gases must not be used as earth connections. Earth connections must never be made up of a metal part simply submerged in water.

Figure 51. Placement of a grounding stake

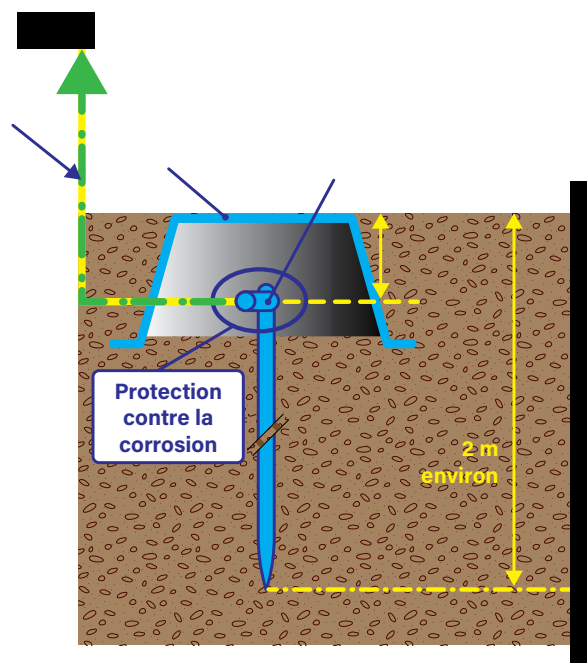

Identification of electrical components

As a basic requirement for every electrical installation, circuits should be clearly identified inside the breaker boards.

- power panel (PP), containing commutation devices for power;
- main distribution panel (DP);
- main distribution lines (A, B, C, D, etc.).

The national standard colour-coding system should be respected.

For final circuits on the final boards, use numbers rather than letters, as there could be more than 25 circuits in a panel. Use a lower-case "c" to indicate this is a final circuit, e.g. c1, c2, c3.

Equipment: quality and usage requirements

Electrical installations are made up of only cables, junctions, enclosures, switchgears and protections.

Cables must be according to the situation and usage requirements. All the electrical power supplied to sockets, lights and other user terminals is delivered through a network of cables and wires – hence, cables and wires are the most important part of an electrical installation.

The minimum diameter of a round pipe used as electrical channel is 2 cm. The minimum diameter of a round pipe used as an electrical channel should be at least twice the diameter of the wires or the cable passing through it.

The following letters are used to identify terminals:

- power sockets: P
- lights: L
- switches: S
- junctions: J.

As the structures of the centre are temporary, it will be necessary to pay particular attention during the installation of the terminals (power sockets, lights, switches, junction). All terminals and air extractors must be fixed with wooden plates (20 × 20 × 2 cm).

Identification rules for a coronavirus centre

Each building, part of a building, or functional group of buildings is identified by a zone letter (e.g. A, B, C).

Each room inside of zone is identified by a number following the identification letter of the zone (e.g. A1, A2, A3, B1, B2, B3).

Corridors, access areas and passages are identified by preceding the identification code with an "X" (e.g. XA1, XA2, XB1, XB2).

Outdoor spaces are identified by preceding the identification code with a "Z" (e.g. ZA1, ZA2, ZB1, ZB2).

To aid clarity, all identification references should be written on the doors or door jambs of all rooms.

Choosing the correct equipment

Choice may be limited by the availability of suppliers and manufacturers. Local purchase is preferred for many good reasons, but it is often a challenge to find the required quality. The following suggestions may help when choosing supplies:

- Look for the representatives and official suppliers of international brands.
- Look for national distributors and ask who their main clients and local suppliers are.
- Look for consumers with similar needs and requirements and ask them where they found the right products and services.
- When national distributors cannot meet specific requirements (e.g. B curve breakers), be aware that delivery times may be very long.
- Always order using the original reference code from the brand.
- If there is any doubt on the quality or authenticity of a supply, always prefer international purchases.

Energy consumption

Table 14 shows the energy consumption of each zone of a SARI treatment centre.

Table 14. Energy consumption of each zone in a severe acute respiratory infections treatment centre

Zone	Name	Consumption (kVA)	Power (kW)	Main-line cable section (240 V) (mm²)
A	Triage/reception	3.3	3.0	1.5
B	Mild ward	6.2	5.0	4.0
C	Moderate ward	25.0	20.0	35.0
D	Laboratory	21.3	17.0	25.0
E	Severe ward	26.1	21.0	35.0
F	Laundry/sterilization	16.2	13.0	16.0
G	Morgue/water, sanitation and hygiene area	3.9	3.5	1.5
H	Staff area	2.1	1.7	1.5
	P(VA) max total ¹	104.1	84.0	

¹ P(VA) max total is an approximate value that will only come into play for the generator characteristics.

The main line is the line that links the generator or energy source to the specific area (e.g. the main line for the laboratory will be the D1 line, measuring 25 mm²) through the electrical board.

Table 15 shows the maximum circuit breaker sizes and minimum cable sections required.

Table 15. Maximum circuit breaker sizes and minimum cable sections

Maximum circuit breaker size (A)	Minimum cable section (mm²)
10	1.5
16	1.5
20	2.5
25	4.0
32	6.0
40	10.0
50	10.0
63	16.0
80	25.0
100	35.0
125	50.0
160	70.0
200	95.0
250	120.0

Implementation of electrical project

Before implementing the project, ensure the following:

- The supplies, materials and tools have been delivered and are stored in a dedicated warehouse, and an inventory has been made if the work or part of the work is done in house.
- The contractor has been designated and a contract for works has been signed if the work is outsourced.
- The phasing of the work has been prepared.
- The project supervision team has been identified, and the distribution of tasks and responsibilities is clear.
- Everything has been organized so the people working and living in the place where the work is being done feel comfortable.

Before starting work, check the following:

- All equipment and pieces of furniture that must be moved to free the space have been moved, stored in the correct place, and protected as required, in accordance with the people living and working on the site.
- Dedicated secure places have been found to store the supplies and tools on site.

When executing the work, ensure the following:

- Everything that must be removed or dismantled has been removed or dismantled.
- The exact position of all terminals and boards is clearly marked on site.
- All mounting blocks (empty plastic boxes that will hold the terminals) are put in place with their cable entries set in the right number and position.
- All boards (e.g. breaker boxes) are prepared. According to the size and weight of the boards, empty boxes may be installed at the same time as the mounting blocks of terminals are installed. Alternatively, boards can be prepared in advance, with all modular devices already in place on their rails and all internal wiring of the boards prepared in advance; then the boards can be put in place with all their equipment already set in place. Note, however, it is often easier to place empty boards first.
- All junction boxes, channels, pipes and trunks are put in place between the board and all mounting boxes of terminals.
- All cables and wires are put into the pipes and trunks.
- All identifications of wires are always made as the work progresses.
- All terminals are installed and wired into their mounting boxes.
- All wires entering the breaker board are connected to the modular devices.
- All identifications are reported on the modular devices.
- According to the situation, circuits can be tested one by one as the work progresses or after all wiring jobs are complete.

On completion of the work, ensure the following:

- All identifications are updated.
- All drawings and diagrams are updated.
- A copy of the updated position and electrical diagram is placed inside each board. (These diagrams concern only the area and circuits supplied by the board.)
- The site of the work is completely cleaned off, and all remaining tools, supplies, accessories and wastes are evacuated.
- When all remaining tools, supplies and accessories are back in the warehouse, a final inventory is established.
- A list of any tools that have been damaged or lost is established, and tools are cleaned, controlled and maintained.

Building equipment and power requirements

Table 16 gives an estimation of the electrical material and equipment required for a SARI treatment centre.

Table 16. Estimation of electrical material and equipment required for a severe acute respiratory infection treatment centre

Equipment	Location	Quantity	Power (W)	Price/unit (US\$)	Total cost (US\$)
Generator, 110 kVA prime, 220 V/380 V diesel, 50 Hz, canopy		2		25 000.0	50 000
Grounding kit	Generator	2		180.0	360
Tool kit		1		190.0	190
Spare-parts kit		2		10 000.0	20 000
Electrical panel equipped and pre-wired		6		500.0	3000
Lighting line 3G 1.5 mm ² , 100 m/roll		16		50.0	800
Lamp		140	60	10.0	1400
Lamp		30	100	20.0	600
Outdoor lamp		20	60	15.0	300
Lamp		10	40	10.0	100
Mural switch		100		6.5	650
Ground earth cable, Fil H07VR 16 mm ² – green/yellow	General needs	100		3.5	350
Power sockets		100	0	3.5	350
Main line ø 35 mm ² (cable RO2V U1000 R2V 4G 35 mm ²), m		300		8.5	2550
Power sockets line, cable 3G 2.5 mm ² , 100 m/roll		16		73.0	1168
Junction box, 80 × 80 × 35 mm		160		1.5	240
Ground galvanized earth rod, 1.5 m		20		10.0	200
UVC lamp		60	40	50.0	3000
Air extractor		35	50	121.0	4235
Total (US\$)					89 493

References

- 1 Infection prevention and control of epidemic- and pandemic-prone acute respiratory infections in health care. Geneva: World Health Organization; 2014.
- 2 Coronavirus. Geneva: World Health Organization; 2020 (<https://www.who.int/health-topics/coronavirus>).
- 3 International health regulations. Geneva: World Health Organization; 2005.
- 4 Infection prevention and control during health care when novel coronavirus (nCoV) infection is suspected: interim guidance January. Geneva: World Health Organization; 2020.
- 5 WHO guidelines on hand hygiene in health care: first global patient safety challenge – clean care is safer care. Geneva: World Health Organization; 2009.
- 6 Rational use of personal protective equipment for coronavirus disease 2019 (COVID-19). Geneva: World Health Organization; (<https://www.who.int/csr/resources/publications/putontakeoff>).
- 7 How to put on and take off personal protective equipment (PPE). Geneva: World Health Organization; 2014.
- 8 Infection prevention and control recommendations during health care when COVID-19 infection is suspected. Interim guidance. Geneva: World Health Organization; 2020.
- 9 Perform a particulate respirator seal check. Geneva: World Health Organization; 2007.
- 10 Ventilation: engineering controls for TB. Lansing, MI: Michigan Occupational Safety and Health; 2017.
- 11 Atkinson J, Chartier Y, Pessoa-Silva CL, Jensen P, Li Y. Natural ventilation for infection control in health-care settings. Geneva: World Health Organization; 2009.
- 12 Managing epidemics: key facts about major deadly diseases. Geneva: World Health Organization; 2018.
- 13 Awbi HB. Ventilation and air distribution systems in buildings. *Front Mech Eng.* 2015;doi:10.3389/fmech.2015.00004.
- 14 Tuberculosis infection control. Atlanta, GA: Centers for Disease Control and Prevention; 2017.
- 15 Scott J, Zanoni P-G. Guidelines for use of portable air filtration systems in health care facilities. Lansing, MI: Michigan Department of Licensing and Regulatory Affairs; 2012.
- 16 Portable HEPA units. Durham, NC: Biological Safety Division, Duke University; 2014.
- 17 Guidelines for environmental infection control in health-care facilities. Atlanta, GA: Centers for Disease Control and Prevention; 2003 (<https://www.cdc.gov/infectioncontrol/guidelines/environmental/background/air.html#c3b>).
- 18 Kowalski W. Ultraviolet germicidal irradiation handbook: UVGI for air and surface disinfection. Berlin: Springer; 2009.
- 19 Tseng CC, Li CS. Inactivation of virus-containing aerosols by ultraviolet germicidal irradiation. *Aerosol Sci Technol.* 2005;39:1136–42.
- 20 Welch D, Buonanno M, Grilj V, Shuryak I, Crickmore C, Bigelow AW, et al. Far-UVC light : a new tool to control the spread of airborne-mediated microbial diseases. *Sci Rep.* 2018;doi:10.1038/s41598-018-21058-w.

- 21 Seltsam A. Inactivation of three emerging viruses – severe acute respiratory syndrome coronavirus, Crimean-Congo haemorrhagic fever virus and Nipah virus – in platelet concentrates by ultraviolet C light and in plasma by methylene blue plus visible light. *Vox Sang*. 2020;doi:10.1111/vox.12888.
- 22 Reed NG. The history of ultraviolet germicidal irradiation for air disinfection. *Publ Health Rep*. 2010;125:15–27.
- 23 Ultraviolet radiation as a hazard in the workplace. Geneva: World Health Organization; 2003.
- 24 Testing and troubleshooting of ventilation systems. Carolinas Section AIHA; (<http://www.aiha-carolinas.org/downloads/spring-12-meeting/testingAndTroubleshooting.pdf>).
- 25 Interim guidance for environmental infection control in hospitals for Ebola virus. Atlanta, GA: Centers for Disease Control and Prevention; 2014 (<https://www.cdc.gov/vhf/ebola/healthcare-us/cleaning/hospitals.html>).
- 26 Talbot EA, Jensen P, Moffat HJ, Wells CD. Occupational risk from ultraviolet germicidal irradiation (UVGI). *Int J Tubercul Lung Dis*. 2002;6(8):738–41.
- 27 WHO–UNICEF technical specifications and guidance for oxygen therapy devices. Geneva: World Health Organization; 2019.
- 28 Hospital preparedness for epidemics. Geneva: World Health Organization; 2014.
- 29 Clinical management of severe acute respiratory infections when novel coronavirus is suspected: what to do and what not to do. Geneva: World Health Organization; 2020.
- 30 Clinical management of severe acute respiratory infection when novel coronavirus (nCoV) infection is suspected. Geneva: World Health Organization; 2020.
- 31 Best practices for environmental cleaning in healthcare facilities in resource-limited settings. Atlanta, GA: Centers for Disease Control and Prevention; 2019.
- 32 Guidelines on core components of infection prevention and control programmes at the national and acute health care facility level. Geneva: World Health Organization; 2016.
- 33 Minimum requirements for infection prevention and control programmes. Geneva: World Health Organization; 2019.
- 34 Disinfectants for use against the Ebola virus. Washington, DC: United States Environmental Protection Agency; 2018.
- 35 Products with emerging viral pathogens and human coronavirus claims for use against SARS-CoV-2. Washington DC: United States Environmental Protection Agency; 2020.
- 36 Water, sanitation, hygiene and waste management for COVID-19. Geneva: World Health Organization; 2020.
- 37 Decontamination and reprocessing of medical devices for health-care facilities. Geneva: World Health Organization; 2016.
- 38 How to conduct safe and dignified burial of a patient who has died from suspected or confirmed Ebola or Marburg virus disease. Geneva: World Health Organization; 2017.
- 39 COVID-19: control and prevention. Washington, DC: Occupational Safety and Health Administration; 2020 (<https://www.osha.gov/SLTC/covid-19/controlprevention.html>).
- 40 Precautions for handling and disposal of dead bodies, 10th edition. Kowloon: Department of Health, Hospital Authority, Food and Environmental Hygiene Department; 2020.

- 41 Scheerlinck L. Supplies for EVD outbreak response: body bags. Copenhagen: United Nations Children's Fund Supply division; 2018.
- 42 Laboratory biosafety guidance related to the novel coronavirus (2019-nCoV). Geneva: World Health Organization; 2020 (<https://www.who.int/publications-detail/laboratory-testing-for-2019-novel-coronavirus-in-suspected-human-cases-20200117>).
- 43 Laboratory testing for 2019 novel coronavirus (2019-nCoV) in suspected human cases. Geneva: World Health Organization; 2020 (https://www.who.int/docs/default-source/coronaviruse/laboratory-biosafety-novel-coronavirus-version-1-1.pdf?sfvrsn=912a9847_2).
- 44 Essential environmental health standards in health care. Geneva: World Health Organization; 2008.
- 45 The Sphere handbook: humanitarian charter and minimum standards in humanitarian response. Geneva: Sphere; 2018.
- 46 Public health engineering in precarious situations. Geneva: Médecins sans Frontières; 2010.
- 47 Safe management of wastes from health-care activities. Geneva: World Health Organization; 2014 (https://apps.who.int/iris/bitstream/handle/10665/85349/9789241548564_eng.pdf?sequence=1).
- 48 Guidelines on sanitation and health. Geneva: World Health Organization; 2018.

Annex 1: How to perform a particulate respirator seal check

HOW TO



Perform a particulate respirator seal check

WHO/CDS/EPR/2007.8b

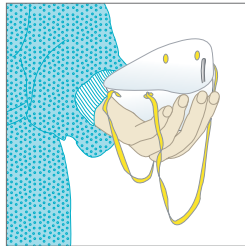

Step 1

- Cup the respirator in your hand with the nosepiece at your fingertips allowing the headbands to hang freely below your hand.



Step 2

- Position the respirator under your chin with the nosepiece up.



Step 3

- Pull the top strap over your head resting it high at the back of your head. Pull the bottom strap over your head and position it around the neck below the ears.



Step 4

- Place fingertips of both hands at the top of the metal nosepiece. Mould the nosepiece (USING TWO FINGERS OF EACH HAND) to the shape of your nose. Pinching the nosepiece using one hand may result in less effective respirator performance.



Step 5

- Cover the front of the respirator with both hands, being careful not to disturb the position of the respirator.

Step 5a: Positive seal check

- Exhale sharply. A positive pressure inside the respirator = no leakage. If leakage, adjust the position and/or tension straps. Retest the seal. Repeat the steps until the respirator is secured properly.

Step 5b: Negative seal check

- Inhale deeply. If no leakage, negative pressure will make respirator cling to your face.
- Leakage will result in loss of negative pressure in the respirator due to air entering through gaps in the seal.

Epidemic and Pandemic Alert and Response © World Health Organization 2008. Design and layout by Engage Write & Design. www.engage-geneva.ch

Reproduced from "Infection prevention and control of epidemic- and pandemic-prone acute respiratory diseases in health care - WHO Interim Guidelines" available at http://www.who.int/csr/resources/publications/WHO_CD_EPR_2007_6/en/index.html

Annex 2: Donning and doffing personal protective equipment

HOW TO PUT ON AND TAKE OFF

Personal Protective Equipment (PPE)



How to put on PPE (when all PPE items are needed)

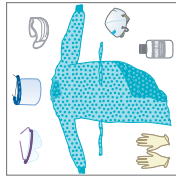

Step 1

- Identify hazards & manage risk. Gather the necessary PPE.
- Plan where to put on & take off PPE.
- Do you have a buddy? Mirror?
- Do you know how you will deal with waste?

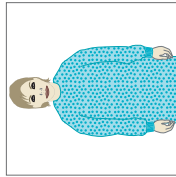

Step 2

- Put on a gown.

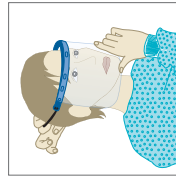

Step 3a

- Put on face shield.

OR

Step 3b

- Put on medical mask and eye protection (e.g. eye visor/goggles)



+

Note: If performing an aerosol-generating procedure (e.g. aspiration of respiratory tract, intubation, resuscitation, bronchoscopy, autopsy), a particulate respirator (e.g. US NIOSH-certified N95, EU FFP2, or equivalent respirator) should be used in combination with a face shield or an eye protection. Do user seal check if using a particulate respirator.

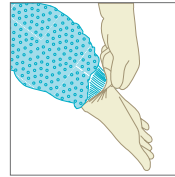

Step 4

- Put on gloves (over cuff).

How to take off PPE

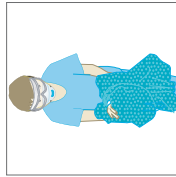

Step 1

- Avoid contamination of self, others & the environment
- Remove the most heavily contaminated items first

Remove gloves & gown

- Peel off gown & gloves and roll inside, out
- Dispose gloves and gown safely

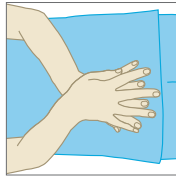

Step 2

- Perform hand hygiene

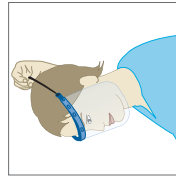

Step 3a

If wearing face shield:

- Remove face shield from behind
- Dispose of face shield safely

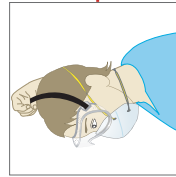

Step 3b

If wearing eye protection and mask:

- Remove goggles from behind
- Put goggles in a separate container for reprocessing
- Remove mask from behind and dispose of safely

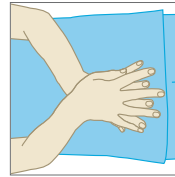

Step 4

- Perform hand hygiene

Annex 3: Severe acute respiratory infection treatment centre layout

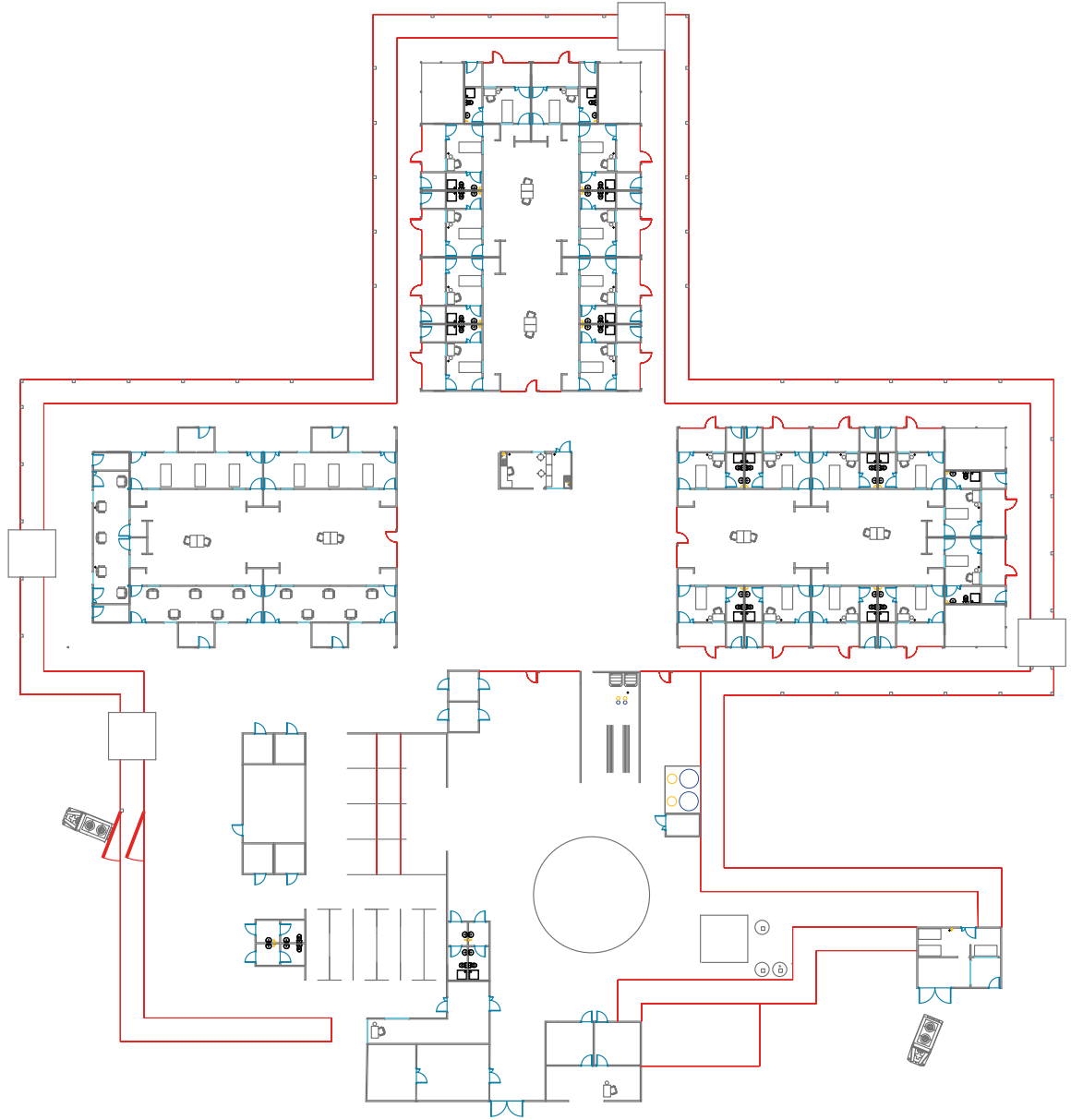

Annex 4: Severe acute respiratory infection treatment centre legend

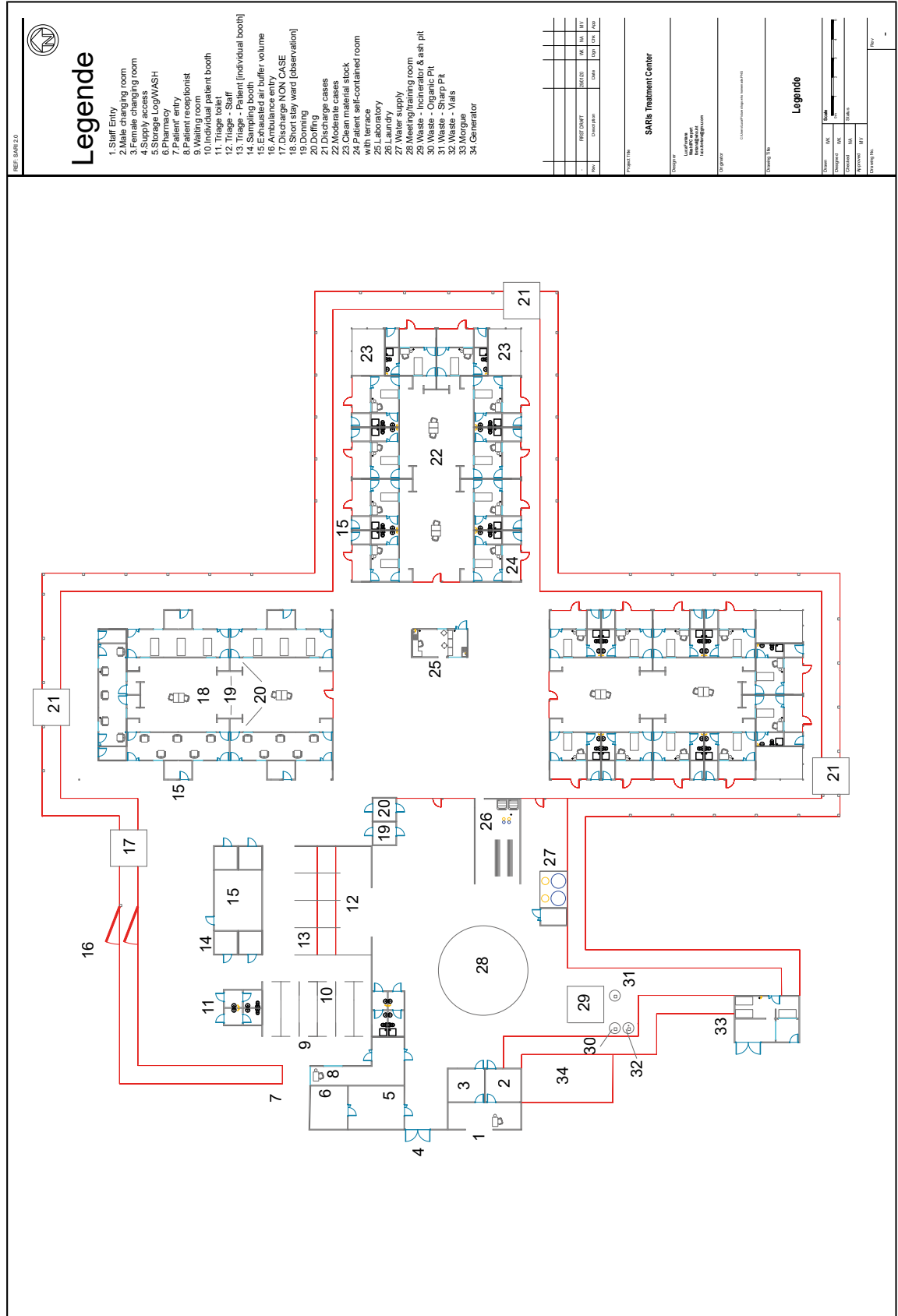

Annex 5: Severe acute respiratory infection treatment centre measures

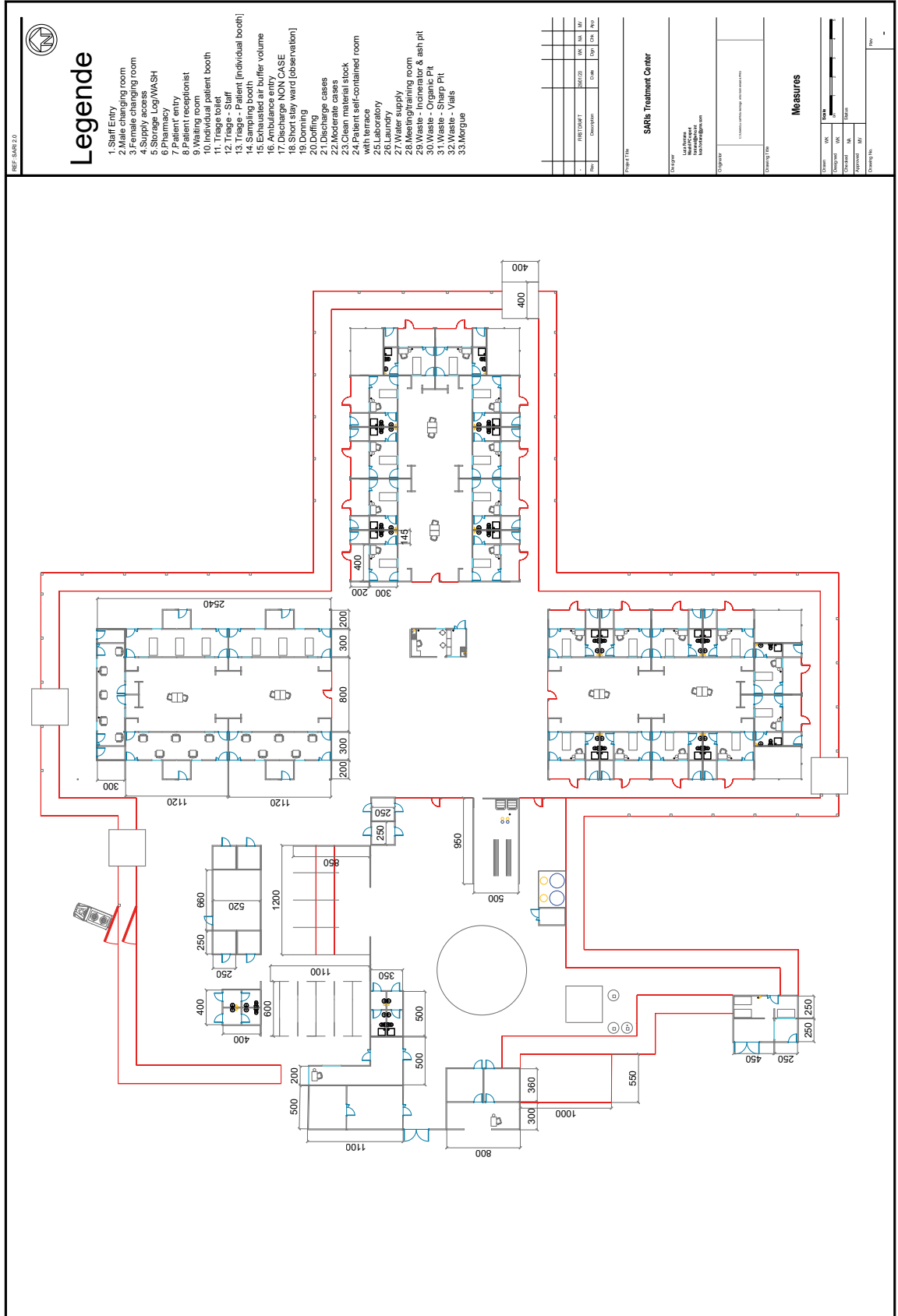

Annex 6: Axonometric view of severe acute respiratory infection treatment centre with roof

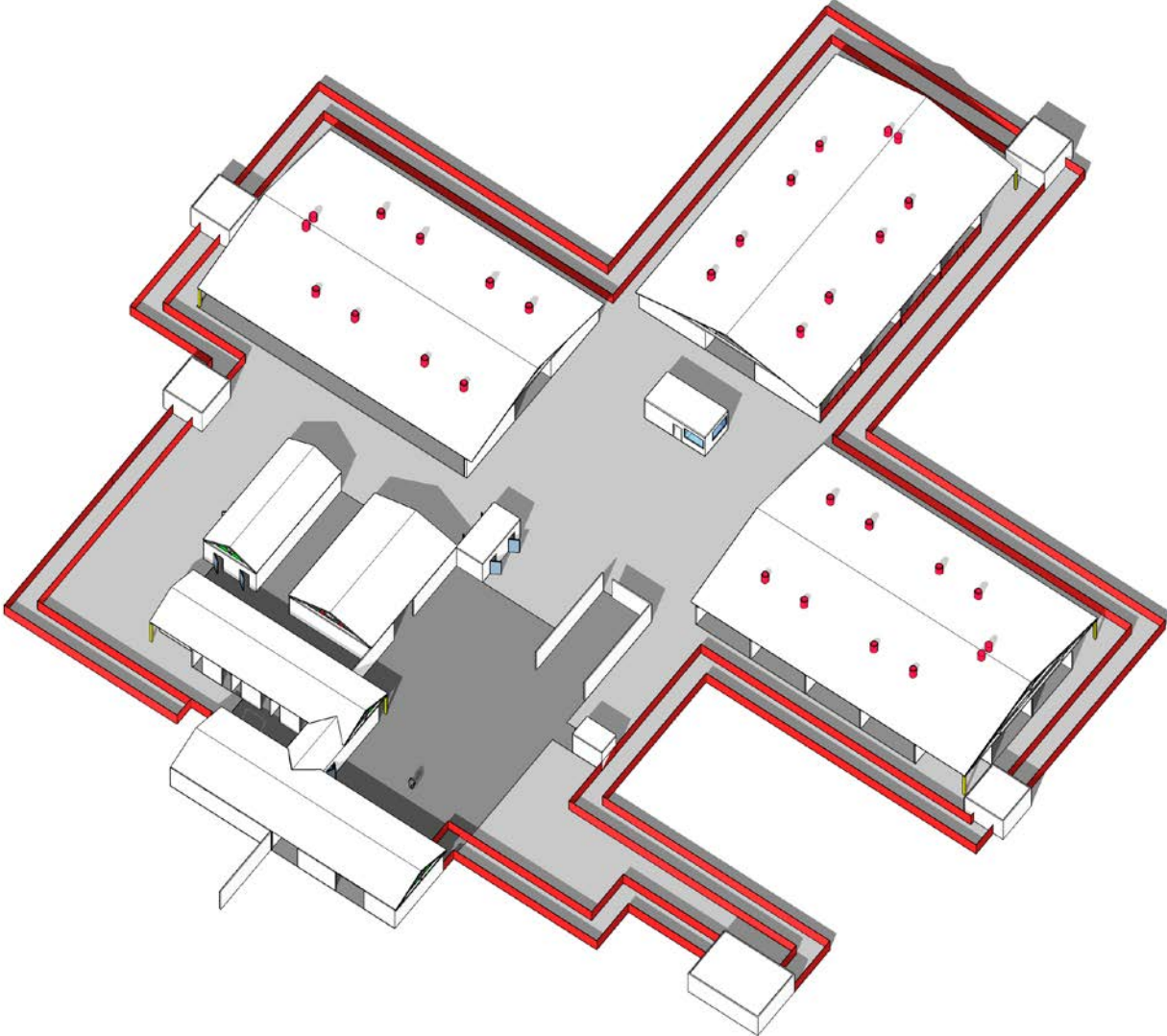

Annex 7: Axonometric view of severe acute respiratory infection treatment centre without roof

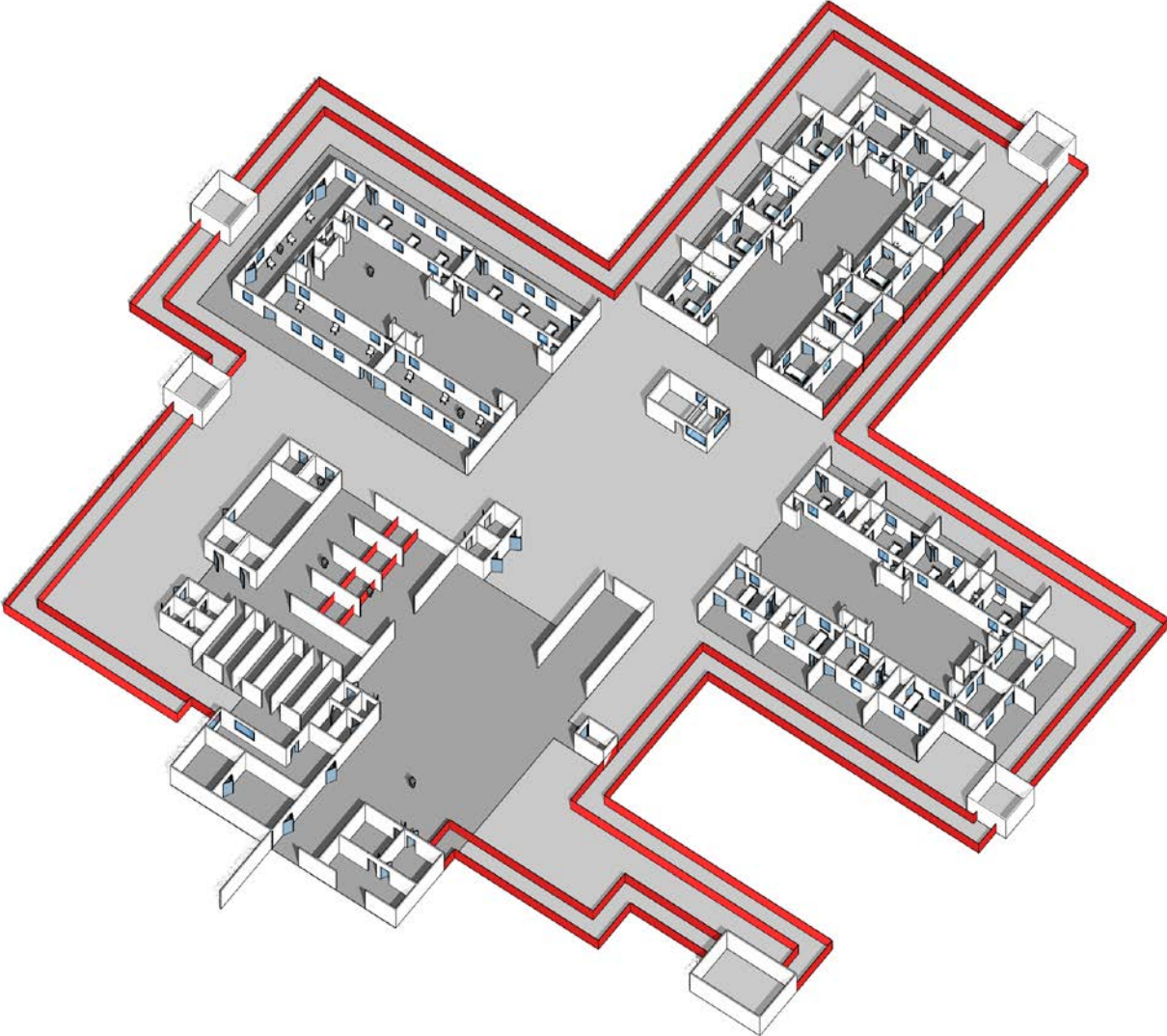

Annex 8: Short-stay ward for mild and moderate cases

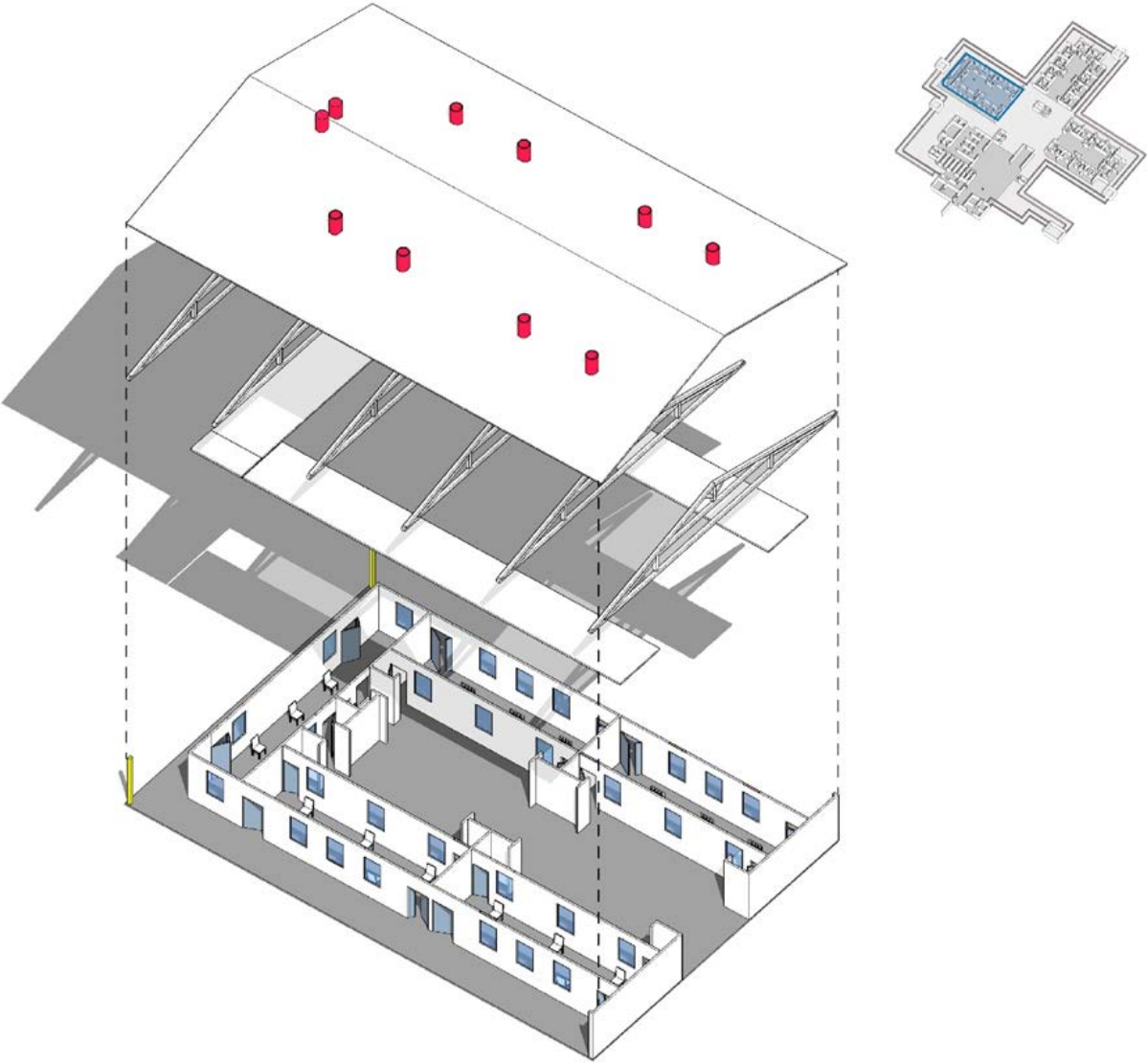

Annex 9: Individual rooms and wards in severe acute respiratory infection treatment centre

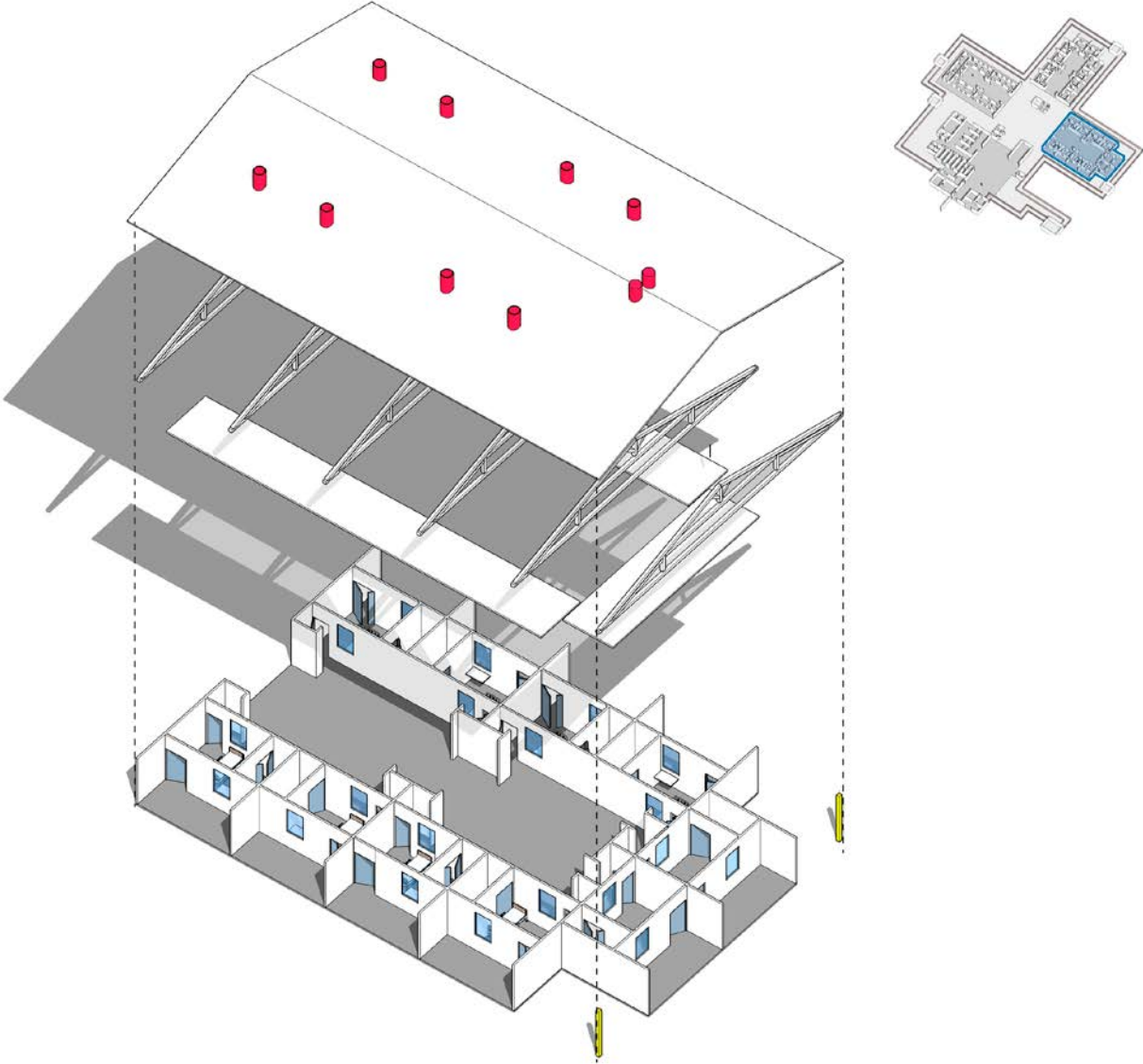

		Short stay ward (mini case ward)											
		12											
Block 6 surface 400 meter square	1.3	Reinforcement concrete (meter cubes)											
	1.4	Steel (meter cubes)	37	25,00									
	1.5	Cement (tote.50kg)	555	12,00									
	1.6	Gravel (meter cubes)	75	25,00									
	1.7	Brickwork (meter cubes)	46		10	10	10	10					
	1.8	Wood (meter cubes)	25	25,00									
	1.9	Plaster (meter cubes)	138	12,00									
	2.0	Cement (tote.50kg)	33	25,00									
	2.1	Wooden frame (boards, beams, rafters, studs, etc.) LxWxH	400	4,00									
	2.2	Wooden boards 300x45x5 cm	1200	3,50									
	2.3	Wooden beams 350x45x5 cm	800	5,00									
	2.4	Steel plate	300	3,00									
	2.5	Plaster (meter square)	660	4,00									
	2.6	Brickwork (meter square)	8	140,00									
	2.7	Plaster (meter square)	20	150,00									
	2.8	Wooden (flooring and frame)	26	100,00									
2.9	Door frame, door, handle and lock (only wood frame and plastic opening)	ff											
3.0	Paint	ff											
3.1	Water excavation system (pipes and piping)	ff											
3.2	Lighting, switches and electrical outlets	ff											
3.3	Manpower (person in number of days)	470	15,00										
4	Subtotal		544,836										
		Moderate case ward											
Block 7 surface 400 meter square	1.3	Reinforcement concrete (meter cubes)	12										
	1.4	Steel (meter cubes)	37	25,00									
	1.5	Cement (tote.50kg)	555	12,00									
	1.6	Gravel (meter cubes)	75	25,00									
	1.7	Brickwork (meter cubes)	46		10	10	10	10					
	1.8	Wood (meter cubes)	25	25,00									
	1.9	Plaster (meter cubes)	138	12,00									
	2.0	Cement (tote.50kg)	33	25,00									
	2.1	Wooden frame (boards, beams, rafters, studs, etc.) LxWxH	400	4,00									
	2.2	Wooden boards 300x45x5 cm	2000	5,00									
	2.3	Wooden beams 350x45x5 cm	450	5,00									
	2.4	Steel plate	300	3,00									
	2.5	Plaster (meter square)	660	4,00									
	2.6	Brickwork (meter square)	8	140,00									
	2.7	Plaster (meter square)	20	150,00									
	2.8	Wooden (flooring and frame)	26	100,00									
2.9	Door frame, door, handle and lock (only wood frame and plastic opening)	ff											
3.0	Paint	ff											
3.1	Water excavation system (pipes and piping)	ff											
3.2	Lighting, switches and electrical outlets	ff											
3.3	Manpower (person in number of days)	470	15,00										
4	Subtotal		583,206										
		Severe case ward											
Block 8 surface 400 meter square	1.3	Reinforcement concrete (meter cubes)	12										
	1.4	Steel (meter cubes)	37	25,00									
	1.5	Cement (tote.50kg)	555	12,00									
	1.6	Gravel (meter cubes)	75	25,00									
	1.7	Brickwork (meter cubes)	46		10	10	10	10					
	1.8	Wood (meter cubes)	25	25,00									
	1.9	Plaster (meter cubes)	138	12,00									
	2.0	Cement (tote.50kg)	33	25,00									
	2.1	Wooden frame (boards, beams, rafters, studs, etc.) LxWxH	400	4,00									
	2.2	Wooden boards 300x45x5 cm	2000	5,00									
	2.3	Wooden beams 350x45x5 cm	450	5,00									
	2.4	Steel plate	300	3,00									
	2.5	Plaster (meter square)	660	4,00									
	2.6	Brickwork (meter square)	8	140,00									
	2.7	Plaster (meter square)	20	150,00									
	2.8	Wooden (flooring and frame)	26	100,00									
2.9	Door frame, door, handle and lock (only wood frame and plastic opening)	ff											
3.0	Paint	ff											
3.1	Water excavation system (pipes and piping)	ff											
3.2	Lighting, switches and electrical outlets	ff											
3.3	Manpower (person in number of days)	470	15,00										
4	Subtotal		583,206										

Annex 11: Furniture and consumables required for severe acute respiratory infection treatment centre

List of items and furniture to open the center plus one-month functioning consumables

Code	Description	Unit	Quantity	Unit cost	Total cost
1	CONTAINER + LID, 120 l	piece	40	\$15.00	\$600.00
1	BASIN, 40 liters, plastic	piece	20	\$5.00	\$100.00
1	MATTRESS COVER, washable, zipper, 220 cm, epidemics	piece	30	\$20.00	\$600.00
1	BED	piece	26	\$150.00	\$3,900.00
1	MATTRESS	piece	30	\$50.00	\$1,500.00
1	MIRROR, classic, 20 x 30 cm	piece	32	\$20.00	\$640.00
1	GARBAGE Bin, 100 liters, + lid, white	piece	60	\$12.00	\$720.00
1	Shelf [2 x 2 x 0,3 m]	piece	25	\$120.00	\$3,000.00
1	BUCKET + LID, 20 l, with tap	piece	80	\$5.00	\$400.00
1	BUCKET + LID, 20 l, food-grade plastic, stackable	piece	50	\$5.00	\$250.00
1	stretcher	piece	4		
1	wheelchair	piece	1		
1	Chairs, plastic	piece	120	\$4.00	\$480.00
1	Set posters of donning/doffing protocols	piece	30	\$2.00	\$60.00
1	Table, plastic	piece	50	\$12.00	\$600.00
2	BROOM, with handle	piece	30	\$3.00	\$90.00
2	CHLORINE, NaDCC granules, 1 kg, jar or HTH (KG)	Kg	500	\$6.00	\$3,000.00
2	Hexanios disinfectant [5 liter tank]	piece	3		
2	SPRAYER, 1 l	piece	10	\$5.00	\$50.00
2	FLOOR SQUEEGEE, with handle	piece	40	\$3.00	\$120.00
2	GARBAGE BAG, 100 liters, black, 70 microns	piece	1000	\$0.02	\$20.00
2	GARBAGE BAG, 40 liters,	piece	1000	\$0.02	\$20.00
2	Hand wash soap, 250ml bottle	piece	300	\$0.50	\$150.00
2	Safety box burnable 5l	piece	100	\$3.00	\$300.00
2	SOAP, 200 g, bar	bar	100	\$2.00	\$200.00
2	OMO soap (5kg) bag	Kg	300	\$3.00	\$900.00
2	Laundry brush plates (plastic)	piece	20	\$3.00	\$60.00
2	Laundry brush boots (wooden) piece	piece	20	\$3.00	\$60.00
2	White vinegar [1 liter bottle]	piece	10	\$2.00	\$20.00
2	BLACK packaging bag with handle 25X33cm,	piece	500	\$0.03	\$15.00
2	Kerosene [waste burning]	Liter	25	\$2.00	\$50.00
2	TAP, 3/4 "plastic	piece	120	\$3.00	\$360.00
2	Wata Test	piece	1	\$20.00	\$20.00
2	Tube for turbidity measurement 5 to 2000 NTU	piece	1	\$50.00	\$50.00

Code	Description	Unit	Quantity	Unit cost	Total cost
2	(pool Tester with Dpd N° 1 / Rapid, 1000 tablets	piece	1	\$50.00	\$50.00
2	MORTUARY BAG, plastic, white, 300 microns, ad., 250x120cm	piece	20	\$20.00	\$400.00
2	MORTUARY BAG, plastic, white, 300 microns, child, 150x100cm	piece	20	\$20.00	\$400.00
2	(body bag) ABSORBENT LAYER	piece	40	\$3.00	\$120.00
3	Disposable plastic PLATE	piece	3000	\$0.20	\$600.00
3	CUP, 250 ml, red, plastic, [patient]	piece	80	\$2.00	\$160.00
3	CUP, 250 ml, green, plastic [staff]	piece	100	\$2.00	\$200.00
3	Paper towel (roll)	piece	200	\$2.00	\$400.00
3	Sanitary napkin (Cotex),	piece	50	\$2.00	\$100.00
3	Diapers adults	piece	50	\$2.00	\$100.00
3	Children's diapers 6-10 kg	piece	50	\$2.00	\$100.00
3	adult blanket	piece	200	\$5.00	\$1,000.00
3	baby blanket	piece	100	\$5.00	\$500.00
3	Bed sheet	piece	300	\$10.00	\$3,000.00
3	body soap 100 gr	piece	150	\$2.00	\$300.00
3	Toilet paper (piece)	piece	400	\$0.50	\$200.00
3	Toilet slipper - flipflop -tong	piece	150	\$4.00	\$600.00
3	Toothpaste with Toothbrush	piece	150	\$3.00	\$450.00
3	men's sandal	piece	80	\$5.00	\$400.00
3	Girl's children's sandals	piece	40	\$5.00	\$200.00
3	Boy's children's sandals	piece	40	\$5.00	\$200.00
3	lady sandal	piece	80	\$5.00	\$400.00
3	Children's clothing from 0 to 5 years old	piece	30	\$5.00	\$150.00
3	Children's clothing from 5 to 12 years old	piece	30	\$5.00	\$150.00
3	Men's adult shirt	piece	80	\$3.00	\$240.00
3	Adult T-shirt	piece	80	\$3.00	\$240.00
3	Kids t-shirt	piece	40	\$3.00	\$120.00
3	Pentalon adult	piece	80	\$5.00	\$400.00
3	Pentalon child	piece	40	\$5.00	\$200.00
3	Jacket adult	piece	50	\$8.00	\$400.00
3	Child jacket	piece	20	\$8.00	\$160.00
3	Men's underwear	piece	80	\$3.00	\$240.00
3	Adult lady dress	piece	80	\$8.00	\$640.00
3	Women's underwear	piece	80	\$3.00	\$240.00
3	Child underwear	piece	40	\$3.00	\$120.00
3	Towel	piece	200	\$4.00	\$800.00
4	PEN, fine point, [50 pieces box]	piece	6	\$5.00	\$30.00
4	MARKER, indelible, large, chisel point, black	piece	20	\$2.00	\$40.00

Code	Description	Unit	Quantity	Unit cost	Total cost
4	MARKER, indelible, large, chisel point, red	piece	20	\$2.00	\$40.00
4	MARKER, indelible, large, chisel point, green	piece	20	\$2.00	\$40.00
4	Duracell AAA 2 battery (pair)	piece	100	\$2.00	\$200.00
4	Duracell AA 2 battery (pair)	piece	50	\$2.00	\$100.00
4	CR 2032 battery	piece	50	\$2.00	\$100.00
4	Clock / pendulum	piece	50	\$6.00	\$300.00
4	Rolls of scotch tape (5cm)	piece	10	\$1.00	\$10.00
4	NOTEBOOK, A4, squared, spiral, 180 pages	piece	50	\$2.00	\$100.00
4	Envelop, Plastic, Transparent, Perforated, A4 Open At The Top	piece	100	\$0.20	\$20.00
4	10/12 folder-pack separation	piece	100	\$0.20	\$20.00
4	Hardcover Notebook, A4, Grid, 80g, 200 Pages	piece	100	\$2.00	\$200.00
4	Paper, A4, 210 X 297 Mm, White, For Photocopy, 80 G	Box	40	\$15.00	\$600.00
4	Notepad, A5, 210 X 140 Mm, Grid 5 Mm	piece	100	\$2.00	\$200.00
4	Punch, Paper, With Guide	piece	20	\$5.00	\$100.00
4	Marker, Erasable, Black, Round Point	piece	50	\$2.00	\$100.00
4	Marker, Green, Erasable, Round Point	piece	50	\$2.00	\$100.00
4	Marker, Blue, Erasable, Round Point	piece	50	\$2.00	\$100.00
4	Marker, Red, Erasable, Round Point	piece	50	\$2.00	\$100.00
Total					\$34,815.00

Annex 12: Personal protective equipment module for severe acute respiratory infection treatment centre based on 100 patients

KMEDCOVK1--A1	KIT, nCov, 100 PATIENTS
KMEDCOV1PPE1-A1	[kit nCov 100 patients] [MODULE, PPE

WHO Code	WHO Description	Qty	Unit Cost USD	Total cost (USD)	Estim. Unit Weight (kg)	Estim. Total Weight (kg)	Estim. Unit Volume (m3)
YMIEQLASW51-A1	GOGGLES PROTECTIVE, wraparound, soft frame, indirect vent.	300	\$ 13.00	\$ 3,900.00	0.86000	258.00	0.00005
PEXTALCO1G-A1	ALCOHOL-BASED HAND RUB, gel, 100ml, bottle	60	\$ 1.29	\$ 77.28	0.12000	7.20	
EWASBAGBR007-A1	BAG BIOHAZARD, REFUSE, AUTOCLAVABLE, 30x50cm, yellow	100	\$ 0.35	\$ 35.00	0.00500	0.50	
EWASYN5G1-A1	CHLORINE NaDCC, 45-55%, gran., 1kg, pot.	8	\$ 6.00	\$ 48.00	1.00000	8.00	
CPPEGOWI3L-A1	GOWN, AAMI level 3, non sterile, disp., size L	540	\$ 0.80	\$ 432.00	0.11467	61.92	0.001125612
CPPEGOWI3M-A1	GOWN, AAMI level 3, non sterile, disp., size M	630	\$ 0.80	\$ 504.00	0.11467	72.24	0.001125612
CPPEGOWI3XL-A1	GOWN, AAMI level 3, non sterile, disp., size XL	450	\$ 0.80	\$ 360.00	0.11467	51.60	0.001125612
CPPEGOWI3XXL-A1	GOWN, AAMI level 3, non sterile, disp., size XXL	180	\$ 0.80	\$ 144.00	0.11467	20.64	0.001125612
CMSUGLEN1L-A1	GLOVE EXAMINATION, nitrile, pf, size L	2200	\$ 0.07	\$ 154.00	0.00707	15.55	0.00003
CMSUGLEN1M-A1	GLOVE EXAMINATION, nitrile, pf, size M	4200	\$ 0.07	\$ 277.20	0.00707	29.69	0.00003
CMSUGLEN1S-A1	GLOVE EXAMINATION, nitrile, pf, size S	4200	\$ 0.07	\$ 277.20	0.00707	29.69	0.00003
CMSUGLEN1XL-A1	GLOVE EXAMINATION, nitrile, pf, size XL	1600	\$ 0.07	\$ 105.60	0.00707	11.31	0.00003
CPPEMSSZRL-A1	MASK SURGICAL, type IIR, level 2, s.u, non sterile, earloop, size L	1100	\$ 0.66	\$ 725.43	0.00421	4.63	0.00004
CPPEMSSZRM-A1	MASK SURGICAL, type IIR, level 2, s.u, non sterile, earloop, size M	1100	\$ 0.66	\$ 725.43	0.00421	4.63	0.00004
CPPEMSSZRS-A1	MASK SURGICAL, type IIR, level 2, s.u, non sterile, earloop, size S	6000	\$ 0.66	\$ 3,956.90	0.00421	25.23	0.00004
CPPEFSHIED02-A1	FACE SHIELD, clear plastic, disp.	2700	\$ 0.43	\$ 1,156.25	0.01000	27.00	
CMSUTHERI01-A1	THERMOMETER, INFRARED, no contact, handheld	30	\$ 25.00	\$ 750.00	0.02000	0.60	0.00005
CMSCONTCS1-A1	SAFETY BOX, needles/syringes, 5l, cardboard for incineration	40	\$ 0.82	\$ 32.87	0.33000	13.20	0.00074
OPACUNG2B51-A1	BOX, triple packaging, biological substance UN3373 +pouch	100	\$ 6.18	\$ 617.75	2.00000	200.00	
OPACUNG2L51-A1	BOX, triple packaging, infectious substance UN2814	20	\$ 30.28	\$ 605.69	2.00000	40.00	
CMSUBAGB4A04-A1	BAG BODY, 8 handles, U-shaped zip, white, 400 microns, adult, 230x100cm	20	\$ 17.80	\$ 356.00	5.00000	100.00	
			\$	\$		986.27	0.006
			\$	\$			

Annex 13: Work uniform module for severe acute respiratory infection treatment centre based on 40 staff members per shift

NOTE: closed shoes are recommended, however, for low resources setting, it is advisable to equip staff with scrubs and rubber boots (local purchases whenever possible). Underneath the recommended quantities for 40 staffs per shift with 4 for shift, morning afternoon, night and recovery.

WHO Code	WHO Description	Qty	Unit Cost USD	Total cost (USD)	Estim. Unit Weight (kg)	Estim. Total Weight (kg)	Estim. Unit Volume (m3)
YPPESTUTROSS-A1	SET, TUNIC + TROUSERS SURGICAL, woven, reusable, green, size [S]	40	\$ 10.45	\$ 418.16	0.541	21.64	0.2
YPPESTUTROSSM-A1	SET, TUNIC + TROUSERS SURGICAL, woven, reusable, green, size [M]	70	\$ 10.45	\$ 731.78	0.541	37.87	0.35
YPPESTUTROSL-A1	SET, TUNIC + TROUSERS SURGICAL, woven, reusable, green, size [L]	60	\$ 10.45	\$ 627.24	0.541	32.46	0.3
YPPESTUTROSLA1	SET, TUNIC + TROUSERS SURGICAL, woven, reusable, green, size [XL]	30	\$ 10.45	\$ 313.62	0.541	16.23	0.15
OLIFBOOTW38--A1	BOOTS, rubber, size [38], dark color (green or black), pair	25	\$ 6.10	\$ 152.50	1.437	35.91666667	0.100
OLIFBOOTW40--A1	BOOTS, rubber, size [40], dark color (green or black), pair	50	\$ 6.10	\$ 305.00	1.437	71.83333333	0.200
OLIFBOOTW42--A1	BOOTS, rubber, size [42], dark color (green or black), pair	40	\$ 6.10	\$ 244.00	1.437	57.46666667	0.160
OLIFBOOTW44--A1	BOOTS, rubber, size [44], dark color (green or black), pair	30	\$ 6.10	\$ 183.00	1.437	43.1	0.120
OLIFBOOTW46--A1	BOOTS, rubber, size [46], dark color (green or black), pair	15	\$ 6.10	\$ 91.50	1.437	21.55	0.060

Annex 14: Biomedical devices needed for severe acute respiratory infection treatment centre

Biomedical devices for case management

* Medical procedures: Intubation / Resuscitation / Oxygen therapy and mechanical ventilation / Injection and Intravenous infusion.

* Is assumed that in every context will be the skills and complementary equipment needed for the set requested.

Medical Purpose	Type	Designation (EN)
Airway Management	Equipment	CRICOTHYROTOMY, SET, emergency, 6 mm, sterile, single use
Airway Management	Consumables	Airway, nasopharyngeal, sterile, single use, set w/range of sizes: 20 to 36 Fr
Airway Management	Consumables	Airway, oropharyngeal, Guedel, sterile, single use, set w/range of sizes: 00, 0, 1, 2, 3, 4, 5
Airway Management	Consumables	ENDOTRACHEAL TUBE INTRODUCER, Bougie, 10 Fr and 15 Fr, 60 cm, sterile, single use
Airway Management	Consumables	ENDOTRACHEAL TUBE INTRODUCER, Stylet, 10 Fr and 14 Fr, 30 to 45 cm, sterile, single use
Airway Management	Consumables	TUBE, ENDOTRACHEAL, No. 2, 2.5, 3, 3.5, 4, 5, without cuff, sterile, single use
Airway Management	Consumables	TUBE, ENDOTRACHEAL, No. 4, 5, 6, 7, 8, 9, with cuff, sterile, single use
Airway Management	Consumables	Laryngeal mask airway (LMA), range of sizes, sterile, single use
Airway Management	Consumables	Colorimetric End Tidal CO2 detector, adult and paediatric, single use
Airway Management	Consumables	Syringe, Luer slip, 10 mL, sterile, single use
Airway Management	Consumables	Lubricating jelly, 5 g
Airway Management	Consumables	FORCEPS, MAGILL, 15/19/24 cm
Airway Management	Equipment	LARYNGOSCOPE, FO, adult/child, diam. 28 mm, with blades
Airway Management	Equipment	LARYNGOSCOPE, FO, neonate, diam. 19 mm, with blades
Blood Chemistry	Equipment	CLINICAL CHEMISTRY ANALYSER with cartridges and control solutions
Blood Chemistry	Consumables	Arterial Blood Sample Kits
Central line	Consumables	Central Venous Catheters kit
Central line	Consumables	Transparent adhesive plasters, wash proof, 5x5 cm
Diagnostic imaging	Equipment	ULTRASOUND, mobile, with LINEAR TRANSDUCER 5.0-7.5 MHz PHASED ARRAY CARDIAC TRANSDUCER 5.0-7.5 MHz
Diagnostic imaging	Consumables	ELECTROCONDUCTIVE GEL, 5L, container
Drug administration	Equipment	INFUSION PUMP, one or two channels, with accessories
Drug administration	Equipment	DRILL, FOR VASCULAR ACCESS, with needles adult and paediatric, and transport bag

Medical Purpose	Type	Designation (EN)
Drug administration	Equipment	SCALE, adult and infant, 50g/0-200kg
Gastro-ental Feeding	Consumables	Tube, feeding, nasogastric, 10 Fr, 50 cm, ENFit tip, sterile, single use
Gastro-ental Feeding	Consumables	Tube, feeding, nasogastric, 12 Fr, 90 cm, ENFit tip, sterile, single use
Gastro-ental Feeding	Consumables	Tube, feeding, nasogastric, 14 Fr, 90 cm, ENFit tip, sterile, single use
Gastro-ental Feeding	Consumables	Tube, feeding, nasogastric, 6 Fr, 50 cm, ENFit tip, sterile, single use
Gastro-ental Feeding	Consumables	Tube, feeding, nasogastric, 8 Fr, 50 cm, ENFit tip, sterile, single use
Gastro-ental Feeding	Consumables	Syringe, feeding, 1 mL, LDT, ENFit, sterile, single use
Gastro-ental Feeding	Consumables	Syringe, feeding, 10 mL, ENFit, sterile, single use
Gastro-ental Feeding	Consumables	Syringe, feeding, 2.5 mL, LDT, ENFit, sterile, single use
Gastro-ental Feeding	Consumables	Syringe, feeding, 20 mL, ENFit, sterile, single use
Gastro-ental Feeding	Consumables	Syringe, feeding, 5 mL, LDT, ENFit, sterile, single use
Gastro-ental Feeding	Consumables	Syringe, feeding, 60 mL, ENFit, sterile, single use
Gastro-ental Feeding	Consumables	Lubricating jelly, 50g, tube
Gastro-ental Feeding	Consumables	Pad, absorbent
Gastro-ental Feeding	Consumables	Basin kidney, stainless steel, 825 mL
Gastro-ental Feeding	Consumables	Stethoscope, binaural, double cup, adult/child, single use
General supplies	Consumables	Compress, gauze, 10 x 10 cm, 8 to 12 ply, sterile, single use
General supplies	Consumables	Tape, surgical, hypoallergenic, 5 x 2.5 cm
General supplies	Consumables	Drape, surgical, non woven, sterile, single use
General supplies	Consumables	Gloves, examination, nitrile, powder-free, pair-packed, sterile, single use
General supplies	Consumables	Antiseptic Wipe with Alcohol & Chlorhexidine
Mechanical ventilation	Equipment	SELF-INFLATING BAG, adult, child and neonate masks
Mechanical ventilation	Consumables	Filter, heat and moisture exchanger (HMEF), high efficiency, with connectors, adult and paediatric, single use
Mechanical ventilation	Equipment	VENTILATOR PATIENT, TRANSPORT, for adult, paediatric and neonate, with accessories
Mechanical ventilation	Equipment	VENTILATOR PATIENT, INTENSIVE CARE, for adult, paediatric and neonate, with accessories
Monitoring	Equipment	MONITOR PATIENT, multiparametric with accessories
Monitoring	Equipment	DEFIBRILLATOR, mobile, with accessories and consumables
Monitoring	Equipment	ELECTROCARDIOGRAPH, with accessories and consumables

Medical Purpose	Type	Designation (EN)
Oxygen therapy	Equipment	PULSE OXYMETER
Oxygen therapy	Equipment	CONCENTRATOR O2 (> 5 L/min) with spare connectors and filters
Oxygen therapy	Accessories	HUMIDIFIER
Oxygen therapy	Accessories	FLOW SPLITTER
Oxygen therapy	Consumables	Nasal cannula with prongs, adult / infant / neonate
Oxygen therapy	Consumables	Mask, oxygen, with connection tube, reservoir bag and valve, high-concentration, non-sterile, single use, adult and paediatric
Oxygen therapy	Consumables	Venturi Mask, with percent O2 Lock and tubing , adult and paediatric
Oxygen therapy	Consumables	Catheter, nasal, 8 Fr, 40 cm, with lateral eyes, sterile, single use
Oxygen therapy	Consumables	CONNECTOR, biconical, symmetric, ext. diam. 7-11 mm
Oxygen therapy	Consumables	TUBE, silicone, autoclavable, int. diam. 5 mm, 25 m
Oxygen therapy	Equipment	CPAP unit with nasal tubing and mask for adult and paediatric
Oxygen therapy	Equipment	Flowmeter, Thorpe tube, for oxygen 0-15L/min
Oxygen therapy	Equipment	High Flow Nasal Cannula, with tubing and accessories
Oxygen therapy	Equipment	SUCTION PUMP, ELECTRICAL, with filters and accessories
Sterilization	Equipment	AUTOCLAVE, with indicators and consumables
Urine collection	Consumables	Bag, collecting, urine, with outlet tap, with non-return valve, 2000 mL, adult, non-sterile, single use
Urine collection	Consumables	Catheter, urethral, Foley, 2-way, range of sizes 8 Fr - 20 Fr, sterile, single use

Annex 15: Severe acute respiratory treatment centre extension plan (cohorting approach)

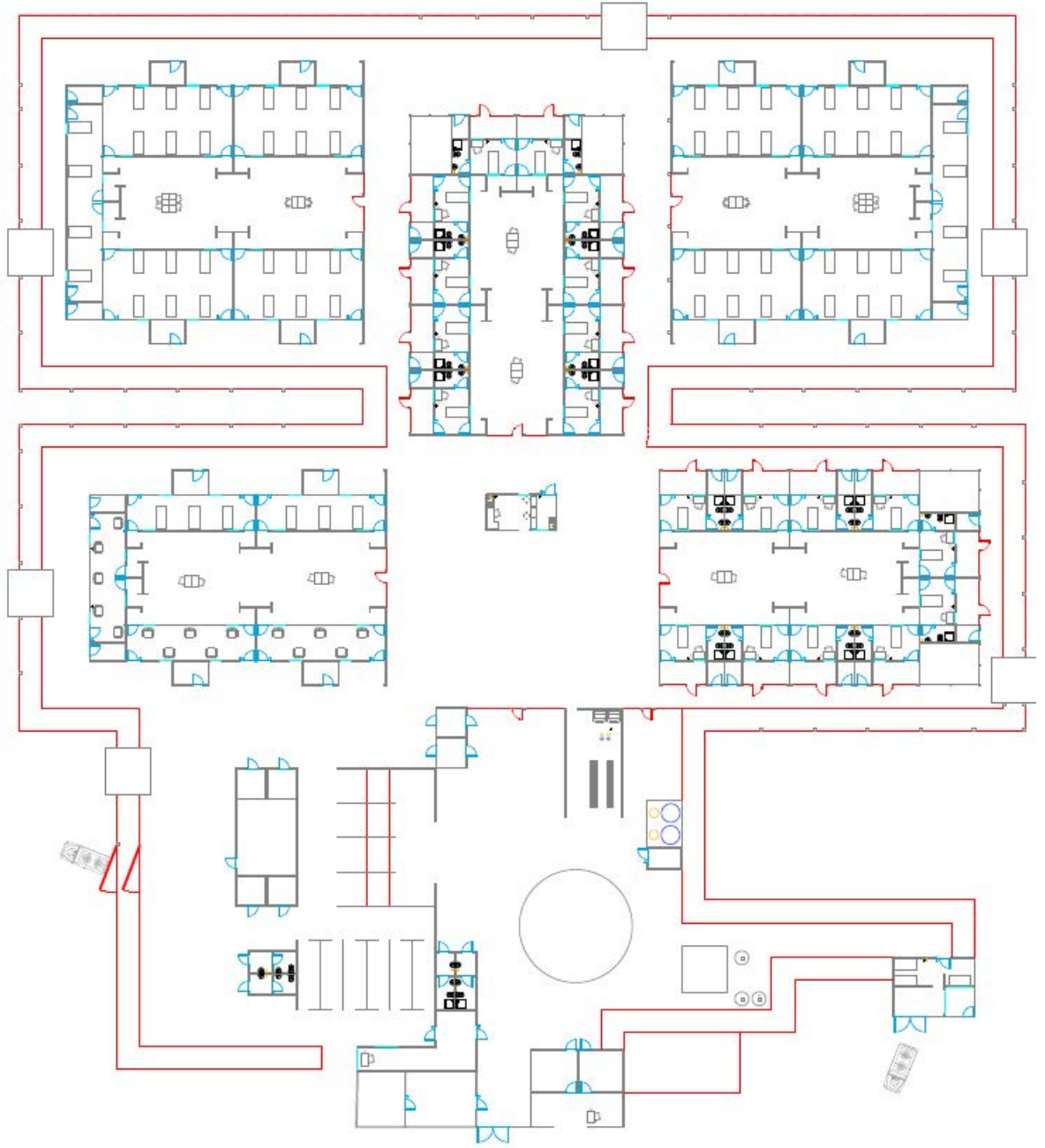

Annex 16: Screening for health facilities description



World Health Organization
Avenue Appia 20
1202 Geneva, Switzerland

Email: oslhealthtech@who.int

